



MATERIAL HANDLING CATALOG



Ballymore Products: PG. 8 - 15

Lift Products Inc. Products: PG. 16 - 45

BALLPALS
PG. 9-12

PORTABLE LOADING DOCKS
PG. 14

BALL TRANSFER TABLE
PG. 15



ERGONOMIC EVALUATOR

- Ballymore Safety Products is proud to provide ergonomic evaluation services through our website.
- With the addition of a certified safety professionals to our staff, we are happy to offer assistance with problem solving related to safety issues that are resulting in back injuries for our customers.

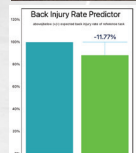
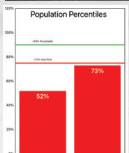

FREE EVALUATION!

LIFT TABLES
PG. 18-27



ROUGH TERRAIN PPJ
PG. 13



BALLYMORE SAFETY PRODUCTS

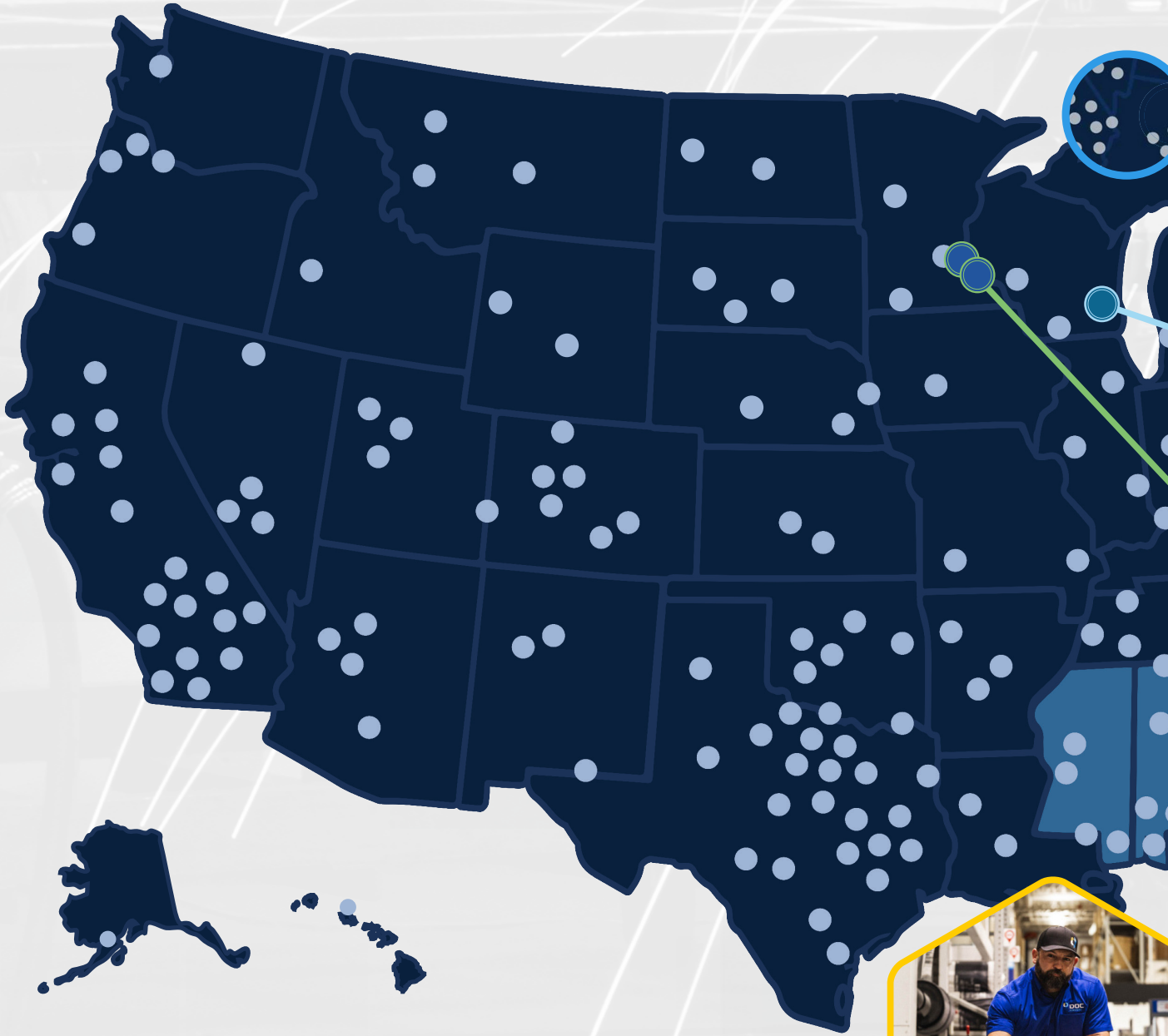

**FINANCING AVAILABLE
ON LIFTS & MATERIAL HANDLING
PRODUCTS OVER \$3,500!**



**AS LOW AS
\$XX.XX
PER MONTH**



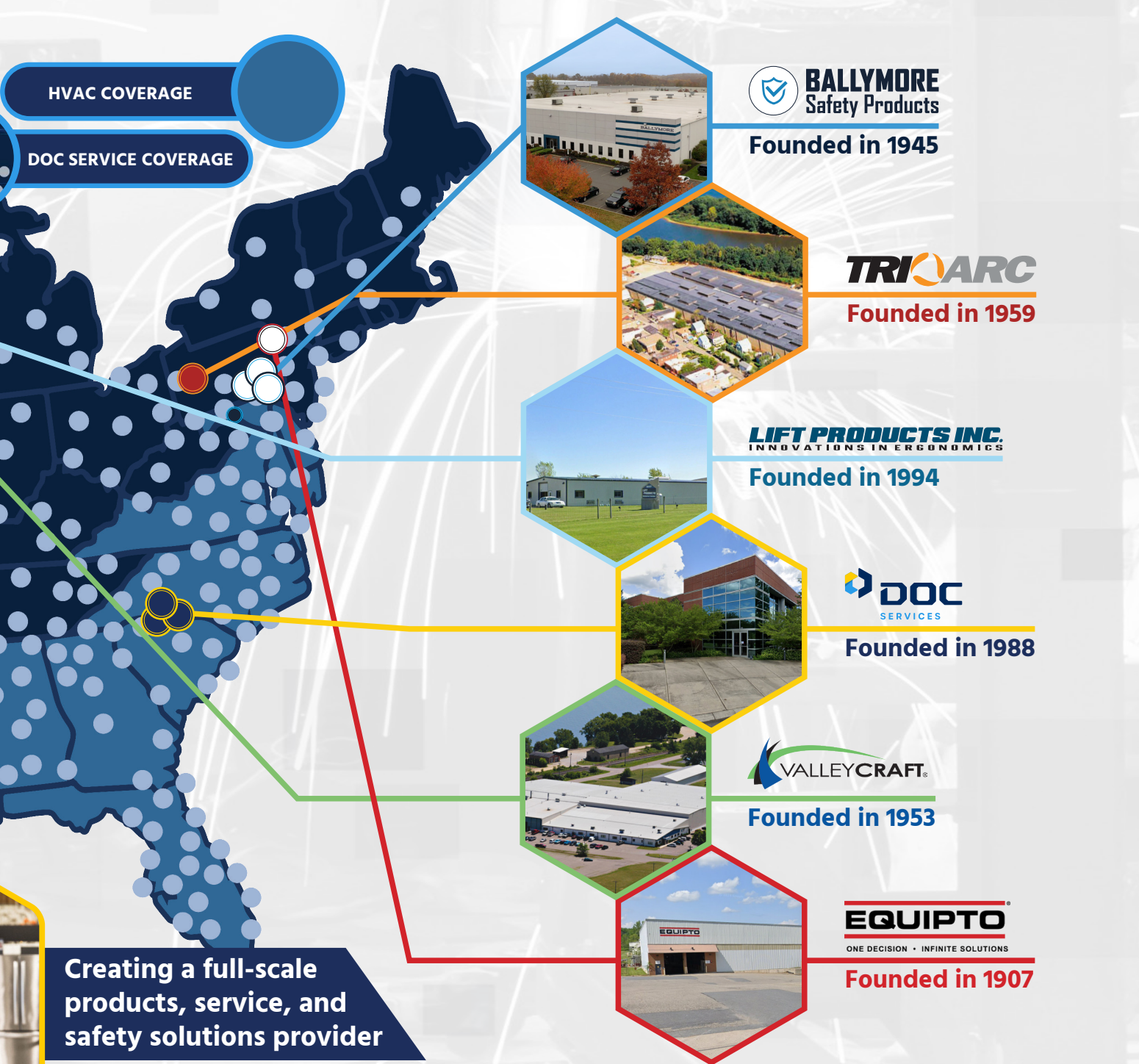
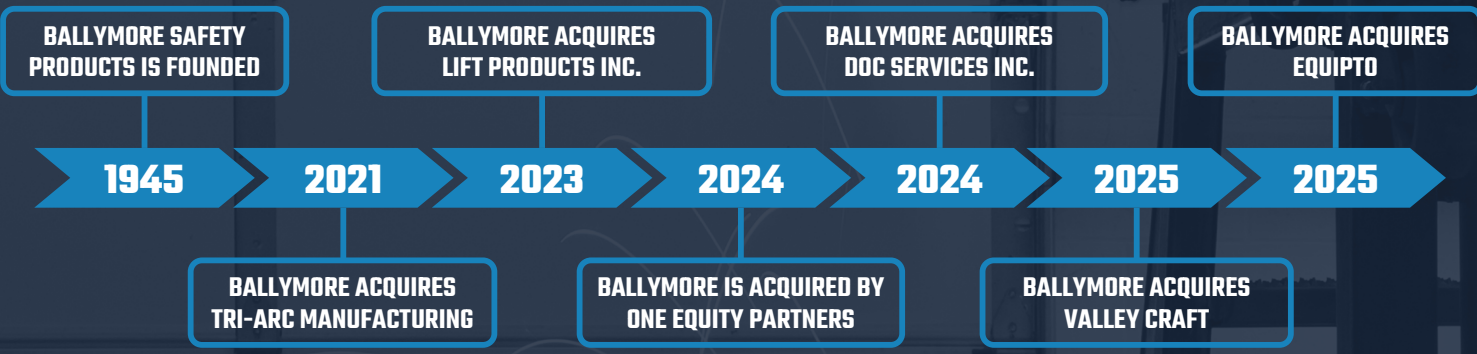

NATIONWIDE SERVICE



TABLE OF CONTENTS



BALLYMORE
Safety Products

Manual Material Handling



Safety products include conveyor tables, paint carts & more. Essential items to enhance worker & customer safety in warehouse and retail settings.

PG.8



BALLYMORE
Safety Products

Ballypal Stackers



Stackers minimize strain & maximize efficiency in pallet handling operations. These fully powered units feature adjustable components, enhancing versatility & productivity in various environments.

PG.9-11



BALLYMORE
Safety Products

Portable Loading Docks



Portable loading docks enable easy loading at dock or truck bed heights. Rough terrain options available. Reduces strain & improves safety across work environments.

PG.14



BALLYMORE
Safety Products

Ball Transfer Table



Portable ball transfer tables allow easy sliding of merchandise, reducing lifting strain and minimizing injury risk. Powered lifting & lowering with pushable and powered-drive options.

PG.15

Have You Wondered the Difference the Right Tool Makes?



ERGONOMIC EVALUATOR

Ballymore Safety Products is proud to provide ergonomic evaluation services through our website!

Scan the QR code for a free safety evaluation.



Ballymore Palletjacks

Powered pallet jacks offer advanced lithium-powered solutions with professional-grade performance. Engineered for durability with a range of capacities & sizes.

PG.12



Trailer Tugger

Trailer tuggers tow & stabilize trailers with combined weights up to 10,000 lbs. This robust machine enhances efficiency & safety in heavy-duty material handling operations.

PG.13



Mobile Platform Lift

The mobile platform lift provides 800lb capacity in a highly portable design. Accommodating various item/package shapes, they reduce lifting strain across a variety workplace settings.

PG.15



Level Loader Table

Level loaders offer an economical solution for palletizing/depalletizing & work positioning, enhancing efficiency and ergonomics with spring or airbag options.

PG.17





TABLE OF CONTENTS

LIFT PRODUCTS INC.
INNOVATIONS IN ERGONOMICS

Lift Tables



Lift tables improve ergonomics of work positioning, available in light to heavy-duty models. Styles include double-high, double-wide, double-long, & more.

PG.18-27

LIFT PRODUCTS INC.
INNOVATIONS IN ERGONOMICS

Mobile Lift Carts



Mobile lift carts offer the ergonomic benefits of lift tables in manual push/lift & electric drive/lift options, enhancing workplace flexibility and efficiency.

PG.28-32

LIFT PRODUCTS INC.
INNOVATIONS IN ERGONOMICS

Tuggers



Tuggers offer a range of capacities and duty levels for towing heavy loads. These versatile machines enhance efficiency & ergonomics in material handling operations.

PG.41

LIFT PRODUCTS INC.
INNOVATIONS IN ERGONOMICS

LPI Palletjacks



Pallet jacks offer powered & manual options with high maneuverability. Easy to operate, they enhance efficiency in various material handling tasks.

PG.42

NATIONWIDE SERVICE



Creating a full-scale products, service, and safety solutions provider



LIFT PRODUCTS INC.
INNOVATIONS IN ERGONOMICS

Tilters

Tilters safely hold and tilt containers for easier access to parts. Designed to improve ergonomics in various industrial settings, enhancing efficiency & safety.

PG.33-37

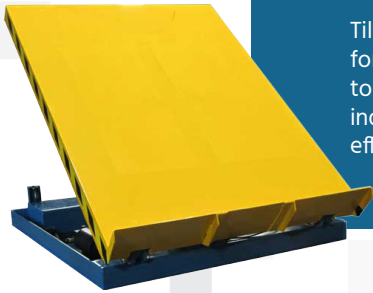

LIFT PRODUCTS INC.
INNOVATIONS IN ERGONOMICS

LPI Stackers

Stackers minimize strain & maximize efficiency in pallet handling operations. Manual & powered units feature adjustable components, enhancing versatility & productivity in various environments.

PG.38-40



LIFT PRODUCTS INC.
INNOVATIONS IN ERGONOMICS

Motorized Carts

Motorized carts offer flexible transportation over carpeting, tile, & hard surfaces, & easily navigate elevators. Adaptable to various workplace needs, enhancing mobility & efficiency.

PG.43-44



LIFT PRODUCTS INC.
INNOVATIONS IN ERGONOMICS

Stainless Steel Lift Tables

The ergonomic improvement & rugged performance of our standard scissor lift tables available in stainless steel for more sensitive environments. Ground entry option available.

PG.45



**FINANCING AVAILABLE
ON MATERIAL HANDLING
PRODUCTS OVER \$3,500!**





Stacking sections provide a compact storage footprint



FINANCING AVAILABLE



CONVEYOR TABLE

- **100 lbs Per Linear Foot**
- Approximately 63' when fully extended
- Omni-directional wheels allow travel in any direction
- Includes extra handle - The conveyor can be split into two sections for dual use
- Weight - 1,225 lbs
- Height ranges from from approx 26" to 42" fully extended
- Stacking sections provide compact storage footprint



FOLDS FOR EASY TRANSPORT & STORAGE

MODEL # BEXCONV-60

PAINT CART

- **Capacity = 400 lbs.**
- Base = 20" Wide X 27" Long
- Shelf - 20" Wide X 20" Long
- Overall Height 42"
- Four Heavy Duty Casters (2 swivel, 2 rigid)
- Weight = 62 lbs.
- Ships Assembled
- Colors Available In Orange or Blue



NOT JUST FOR PAINT CONTAINERS

Perfectly designed patent pending Heavy Duty Paint Cart. The paint cart makes transporting a 5 gallon container quicker and less stressful on the back and shoulders.

MODEL # BPCRT-O

MODEL # BPCRT-B

MERCHANDISE LADDER CART

- **Capacity = 1000 lbs.**
- Base Dimensions= 21"x 51"
- Overall Height= 63"
- Steps= 3 with Abrasive Mat
- Top Shelf Height= 28"
- Top Shelf Dimensions= 20" Wide by 40" Long
- Bottom Shelf Dimensions= 20" Wide by 45" Long
- Casters= 4 - 2 swivels and 2 rigid
- Weight = 108 lbs.



MODEL # BMLC

Ballymore introduces the heavy duty merchandise ladder cart with a capacity of 1,000 lbs. The cart has two large shelves for transporting a variety of merchandise. Ladder portion has a spring loaded device which secures the ladder to the floor when climbing and retracts for easy maneuvering. Cart is equipped with 4 casters- 2 swivels and 2 rigid for effortless turning and moving. Durable powder coated gray with yellow steps.

BALLYPAL 22AG63 & 22AG138 STACKER



BALLYPAL22AG63

Semi Electric Stacker with Adjustable Base Legs. Single Mast with a **Lift Height of 63"**



BALLYPAL22AG138

Semi Electric Stacker with Adjustable Base Legs. Single Mast with a **Lift Height of 138"**

MODEL #	WEIGHT CAPACITY	LIFT HEIGHT MAX	LIFT HEIGHT MIN	FORK LENGTH	FORK WIDTH	BASE LEGS (OD)	OVERALL LENGTH	OVERALL WIDTH	OVERALL HEIGHT	WEIGHT	POWER - BATTERIES
BALLYPAL22AG63	2200	63"	2 1/8"	42"	4"	44" TO 55"	66.5"	44" TO 55"	80"	830	1 X 12V
BALLYPAL22AG138	2200	138"	2 1/8"	42"	4"	44" TO 55"	66.5"	44" TO 55"	89 1/2"	1120	1 X 12V

- **Capacity = 2200 lbs.**
- Forks adjust from side to side to accommodate skid widths
- Adjustable forks lower to the minimum height 2 1/8"
- Distance between fork 8 1/4" to 28 1/2" (Adjustable)
- Straddle legs adjust to three positions
- Sturdy mast made of rolled U-shapes
- Powerful lift motor 2.1 HP
- Battery gauge and On/Off switch
- Integrated 150 Ah maintenance free battery provides more than enough power to handle heavy duty lifting
- Integrated charger facilitates easy and reliable charging



BALLYPAL22NSL142

LITHIUM
BATTERY POWERED

POWDER COATED TOUGH™



BALLYPAL22NSL114

BALLYPAL 22NSL114 & 22NSL142 ADJUSTABLE LITHIUM STACKER

- **Capacity = 2600 lbs.**
- Battery = 24V / 60AH Lithium
- Duty Cycle per Charge = 4 Hours
- Straddle Legs O.D. = 46" to 58"
- Straddle Legs I.D. = 38" to 50"
- Load Center= 24"
- Travel Speed= 2.61/Laden- 2.80 Unladen
- Overall Width= 47"
- Charger= 25AMP on board

MODEL #	WEIGHT CAPACITY (LBS)	LIFT HEIGHT MAX	FORK LENGTH	FORK WIDTH	BASE LEGS (OD)	OVERALL LENGTH	OVERALL WIDTH	OVERALL HEIGHT (LOWERED)	WEIGHT (LBS)	POWER - BATTERIES
BALLYPAL26NSL114	2600	114"	45"	4"	46" TO 58"	72"	47"	77"	1651	24V
BALLYPAL26NSL142	2600	142"	45"	4"	46" TO 58"	72"	47"	91"	1717	24V

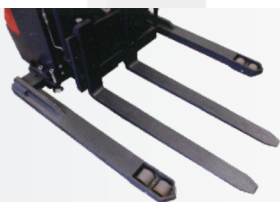

Straddle Leg
Adjustable straddle leg design, suitable for diverse pallet sizes and more stability

Fully Electric Lithium Stacker with Adjustable Base Legs



BALLYPAL 22MSL63 ADJUSTABLE MONO MAST STACKER

- **Capacity = 2200 lbs.**
- Overall Fork Width 10" to 32" (Adjustable)
- Travel Speed = 2.3/2.5 mph
- Max Gradeability= 5% Laden and 10% Unladen

BALLYPAL 22LSL138 ADJUSTABLE DUPLEX MAST STACKER

- **Capacity = 2200 lbs.**
- Overall Fork Width 10" to 32" (Adjustable)
- Travel Speed = 2.3/2.5 mph
- Max Gradeability= 5% Laden and 10% Unladen

BALLYPAL 35TSL157 ADJUSTABLE STACKERS

- **Capacity = 3500 lbs.**
- Overall Fork Width 10" to 29" (Adjustable)
- Travel Speed = 3.5/ 3.7 mph
- Max Gradeability= 6% Laden and 12% Unladen



Fully Electric Mono Mast & Dual Mast Entry Level Stackers

- Mono mast for maximum visibility
- Built- in charger
- Battery discharge indicator with lift lock out for improved battery life
- 3 points design with centered drive for maximum stability and traction
- Two Powerful 12Volt batteries
- Straddle leg width range 46" x 58"



Fully Electric Mono Mast & Dual Mast Entry Level Stackers

- Duplex mast
- Built- in charger
- Battery discharge indicator with lift lock out for improved battery life
- Adjustable straddle leg design for diverse pallet designs and improved stability
- 3 points design with centered drive for maximum stability and traction
- Two powerful 12Volt 85Ah batteries
- Straddle leg width range 46" x 58"



Fully Electric Straddle Leg Walkie Electric Stacker

- Proportional lifting allows for efficient and safe lifting of any product at any lift speed.
- State of the art components
- Mesh protection for safety as well as great visibility during operation
- Robust chassis and thick apron protect the truck and its components
- Three stage mast



FINANCING AVAILABLE

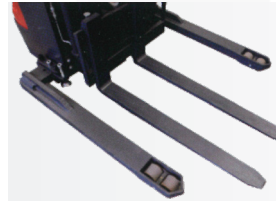

Straddle Leg
Adjustable straddle leg design, suitable for diverse pallet sizes and more stability

MODEL #	WEIGHT CAPACITY	LIFT HEIGHT MAX	FORK LENGTH	FORK WIDTH	LOWERED MAST HEIGHT	FREE LIFT HEIGHT	EXTENDED MAST HEIGHT	HEIGHT OF TILLER IN DRIVE	HEIGHT LOWERED	OVERALL LENGTH	OVERALL WIDTH	WEIGHT	POWER - BATTERIES
BALLYPAL22MSL63	2200	63"	45"	4"	77"	60"	97"	49" MAX	1.6"	71"	46" TO 58"	1,350	2 X 12V
BALLYPAL22LSL138	2200	138"	45"	4"	88"	135"	158"	49" MAX	1.6"	71"	46" TO 58"	1,655	2 X 12V
BALLYPAL35TSL157	3500	157"	45"	4.7"	75"	52"	176"	56" MAX	2"	82"	46" TO 58"	3,263	24V

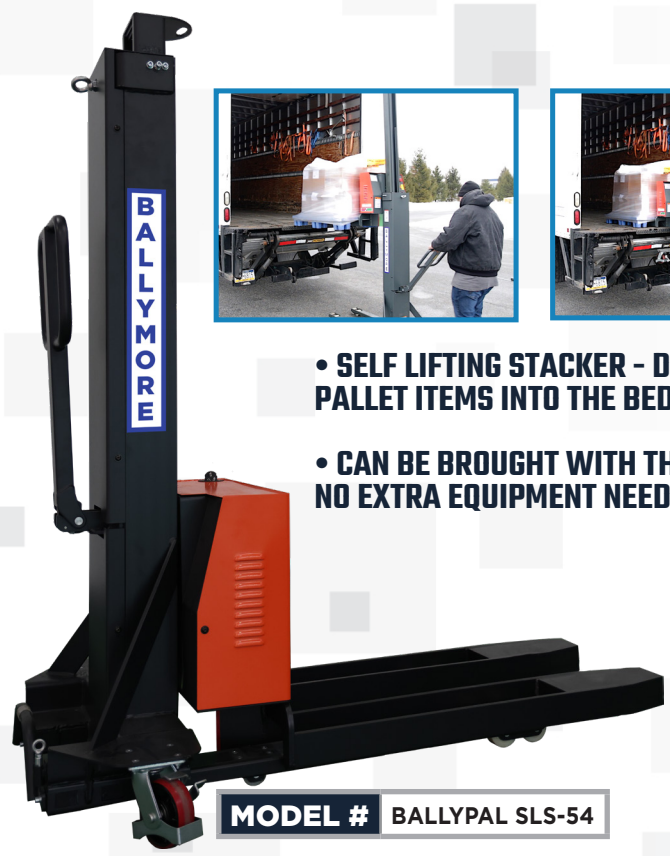

• SELF LIFTING STACKER - DESIGNED TO LIFT ITSELF AND PALLET ITEMS INTO THE BED OF DELIVERY VEHICLES

• CAN BE BROUGHT WITH THE TRUCK TO LOAD AND UNLOAD - NO EXTRA EQUIPMENT NEEDED



MODEL # BALLYPAL SLS-54

BALLYPAL SLS-54 SELF LIFTING STACKER

- Capacity = 1,100 lbs
- Weight= 717 lbs
- Lift Height Max. = 54"
- Fork Length= 43"
- Fork Width= 6.3"
- Distance Between Forks = 21"
- Lowered Mast Height = 66"
- Overall Width 35"
- Overall Length= 63"
- Battery Voltage 1 x 12V



FINANCING AVAILABLE

MAINTENANCE FREE

POWERFUL WITH HIGH GRADEABILITY



Lithium Battery



Intelligent charger

**6S TO REPLACE BATTERY
2 HR TO FULLY CHARGE THE BATTERY**



⚠ Error Code Display
Quickly identify the fault during operation.

Easy parts replacement

The unique design makes disassembly and assembly simple, reducing machine downtime and operating costs.

- 1 minute Replace the drive wheel
- 1 minute Replace the handle
- 2 minutes Remove the controller
- 3 minutes Remove the motor

- **COMFORTABLE OPERATION**
- **LEADING TECHNOLOGY**
- **FAST AND SLOW SPEED**
- **UP-RIGHT DRIVE MODE**

BALLYPAL EPJ SERIES

- Maintenance free 750W/1000W power Brushless motor
- Powered traveling, lifting, & lowering
- Emergency reverse "belly" button
- Fast and Slow Speed
- Up-right Drive Mode
- Engineering Mode - If the unit breaks down, it can be moved away manually
- PIN access control
- Slope anti-sliding design
- Quick charging Lithium Ion battery
- Simple & easy to maintain

MODEL #	WEIGHT CAPACITY	LIFT HEIGHT	HEIGHT OF TILLER IN THE DRIVE POSITION	HEIGHT LOWERED	FORK LENGTH	FORK WIDTH	OVERALL LENGTH	OVERALL WIDTH	WEIGHT	POWER - BATTERIES
BM-EPJ-33S-21	3300	4.5"	49" MAX	3.15"	45.3"	6.3"	61.1"	21.6"	243	48V/15Ah
BM-EPJ-33S-27	3300	4.5"	49" MAX	3.15"	48"	6.3"	63.8"	27"	254	48V/15Ah
BM-EPJ-44S-21	4400	4.5"	49" MAX	3.15"	45.3"	6.3"	61.1"	21.6"	246	48V/15Ah
BM-EPJ-44S-27	4400	4.5"	49" MAX	3.15"	48"	6.3"	63.8"	27"	257	48V/15Ah



Newest Technology Lithium Battery Powered Pallet Trucks - Electric Drive and Electric Lifting and Lowering

BALLYPAL33N PALLET TRUCK

- Capacity = 3300 lbs.
- Travel Speed = 2.85 Laden/2.98 Unladen mph
- Max Gradeability=5% Laden and 16% Unladen
- Battery Voltage 24V /20Ah Lithium

BALLYPAL45N PALLET TRUCK

- Capacity = 4500 lbs.
- Travel Speed = 2.85 Laden/2.98 Unladen mph
- Max Gradeability=5% Laden and 16% Unladen
- Battery Voltage 48V /20Ah Lithium

BALLYPAL45NPRO PALLET TRUCK

- Capacity= 4500 lbs.
- Compact, maintenance-friendly design for work in tight quarters
- On-board charger
- High robustness with 5mm thick fork steel
- Suitable for use in temperature as low as 5 °F
- Optional battery heater
- New generation tiller head with improved ergonomics
- Industry-first serviceable compact lithium battery
- Travel Speed = 3.0 Laden/3.2 Unladen mph
- Max Gradeability=8% Laden and 16% Unladen
- Battery Voltage 48V /20Ah Lithium

BALLYPAL40L PALLET TRUCK

- Capacity= 4000 lbs.
- Travel Speed = 3.1/3.3 mph
- Max Gradeability = 8% Laden and 12% Unladen
- Battery Voltage 24V /160Ah



BALLYPAL33N



BALLYPAL45N



BALLYPAL45NPRO



BALLYPAL40L

MODEL #	WEIGHT CAPACITY	LIFT HEIGHT	HEIGHT OF TILLER IN THE DRIVE POSITION	HEIGHT LOWERED	FORK LENGTH	FORK WIDTH	OVERALL LENGTH	OVERALL WIDTH	WEIGHT	POWER - BATTERIES
BALLYPAL 33N-21	3300	4.5"	46" MAX	3"	45"	6.3"	60"	21"	271	24V
BALLYPAL 33N-27	3300	4.5"	46" MAX	3"	45"	6.3"	60"	27"	278	24V
BALLYPAL 45N-21	4500	4.5"	46" MAX	3"	45"	6.3"	60"	21"	271	48V
BALLYPAL 45N-27	4500	4.5"	46" MAX	3"	45"	6.3"	60.5"	27"	337	48V
BALLYPAL 45N-21-PRO	4500	4.5"	46" MAX	3.2"	45"	6.3"	61"	21"	328	48V
BALLYPAL 45N-27-PRO	4500	4.5"	46" MAX	3.2"	45"	6.3"	61"	27"	337	48V
BALLYPAL 40L	4000	4.7"	48" MAX	3"	48"	6.3"	68"	29"	913	24V
BALLYPAL 45N-27-63	4500	4.5"	46" MAX	3"	63"	6.3"	78.5"	27"	337	48V



The Ballymore Trailer Mover – Efficiently move trailers and ensure stability during loading



SCAN
to see it in action!



10,000 Lb. Capacity!



NEW

TRAILER TUGGER

- **Capacity = 10,000 lbs.**
- Designed to tow and stabilize trailers with a combined weight of up to 10,000 lbs.
- 2,000 lb. counterweight secures trailers during loading/unloading (e.g., skid steer, mini excavator).
- Powered by 48V 20Ah removable Lithium-Ion battery.
- Battery is swappable rechargeable (on/off unit), and fully charges in ~2 hours.

- Charges via standard 120V outlet
- Fits through 42" doors for indoor storage

MODEL #	WEIGHT CAPACITY	LIFT HEIGHT	FORK LENGTH	FORK WIDTH	FREE LIFT HEIGHT	MAX TONGUE WEIGHT	HEIGHT OF TILLER IN DRIVE	HEIGHT LOWERED	OVERALL LENGTH	OVERALL WIDTH	WEIGHT	POWER - BATTERIES
BALLYPAL 45M-TD	10,000	4.5"	45.3"	6.3"	60"	3,000 lbs	45.7" MAX	3.15"	40.2"	27"	2,325	48V/20Ah Lithium

- Powers trailer running lights for visibility.
- Equipped with a flashing light for safety.
- Operates on flat, clear surfaces (concrete/asphalt).
- Proportional forward/reverse thumb controls. Forward and Reverse controls are proportional to how far the thumb controls are moved

NEW

ROUGH TERRAIN POWER PALLET JACK

- **Capacity = 5,000 lbs.**
- Powered in forward or reverse directions
- All-in-one control handle for loading dock steering, movement forward and reverse and platform raising and lowering
- Heavy Duty Capacity– 5,000 lbs.
- Rough Terrain Treaded RT Solid Tires
- Numerous safety features including emergency stop button
- Convenient 110 volt charging
- Battery power indicator
- Built in cycle counter

ALL IN ONE HAND CONTROLS



5,000 Lb. Capacity!

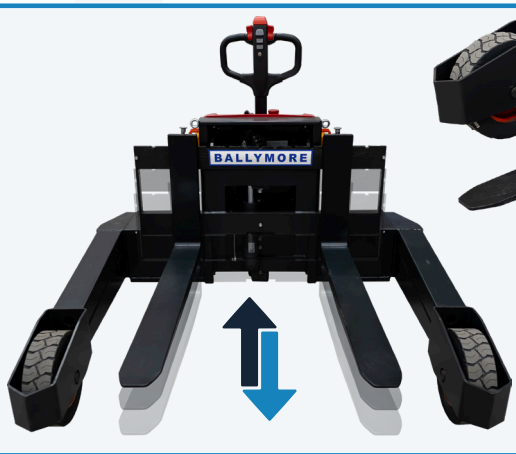

MODEL #	WEIGHT CAPACITY	FORK WIDTH		FORK RAISED MAX	FORK LOWERED	OVERALL LENGTH	OVERALL WIDTH	OVERALL HEIGHT	WEIGHT	POWER - BATTERIES
		MIN	MAX							
RT-PPJ-5K	5,000	9.125"	40.625"	14"	2.5"	66"	63"	49"	1,410	48V/64Ah



FINANCING AVAILABLE



PORTABLE LOADING DOCK

- **Heavy Duty Capacity—1,500 lbs**
- Powered in forward or reverse directions
- All in one Control Handle for steering, movement forward and reverse, and platform raising and lowering
- Large Platform designed to address a wide variety of products
- Key Control Operation
- Fold Down Rails
- Safety Features including Emergency Stop Button
- Convenient 110 volt charging
- Extendable Side Rails
- Battery Power Indicator
- Built in Cycle Counter



SCAN
to see it in action!

PLD-PLUS

Easily load or unload heavy object to dock levels or pickup truck bed heights

MODEL #	CAPACITY	PLATFORM HEIGHT MAX	PLATFORM L X W	WEIGHT	HEIGHT RAISED	HEIGHT LOWERED	BATTERY	OVERALL LENGTH	OVERALL WIDTH
PLD-PLUS	1,500	55"	75" x 47"	2,178	98"	44"	2-12V DC	105"	68"
RT-PLD-5K	5,000	56"	75" x 59"	3,462	106"	52"	48V/85Ah	104"	95"

NEW

ROUGH TERRAIN PORTABLE LOADING DOCK

- **Heavy Duty Capacity—5,000 lbs**
- Powered in forward or reverse directions
- All-in-one control handle for loading dock steering, movement forward and reverse and platform raising and lowering.
- Heavy Duty Capacity— 5,000 lbs.
- Rough Terrain Treaded RT Solid Tires
- Extra large platform designed to address a wide variety of products
- Numerous safety features including emergency stop button
- Convenient 110 volt charging
- Extendable side rails
- Battery power indicator
- Built in cycle counter



RT-PLD-5K



SCAN
to see it in action!

TYPICAL APPLICATIONS

- Strip Malls
- Sites Without Loading Docks
- Farms
- Rough Terrain
- Rental Locations
- Construction Sites
- Gravel Parking Lots
- Sites That Require A Heavier Weight Capacity





BALLYPAL-STK48BC

- This tool turns a lifting or lowering task into a lower risk push or pull.
- The tool allows an employee to slide product on or off a shelf anywhere from 12" high to 48" without lifting.
- Product can be rolled onto the table and rotated to the desired direction with ease.
- Smooth rolling casters. Pushing force on level concrete, when fully loaded =
- Can be used to assist in palletizing / depalletizing heavy product
- Key Controlled
- The balls retract automatically when the table is lowered to provide a secure surface or transport.
- Balls can be raised and lowered independently of the table height control if needed.



BALLYPAL-STK72BC-DRV

BALL TRANSFER TABLE

Pushable:

- **500 lbs Load Capacity**
- Table dimensions - 20" x 35" (leaves room in the aisle for customer to pass by)
- Table contains multi directional ball rollers
- The table height - from 12" to 48"
- Footprint - 21" x 53"
- Weight - 500 lbs
- Overall Height - 51" Lowered

Drivable:

- **500 lbs Load Capacity**
- Table dimensions - 20" x 35"
- Table Dimensions: 31 1/2" W x 36" D
- Overall Height: 89"
- Footprint: 60" Overall Length x 34" Overall Width
- Litium Battery: 24V
- Raised Table Max Height: 72"
- Table Lowered Height: 6 1/2"
- Weight 1,364 Lbs



Removable Deck



NEW

MOBILE PLATFORM LIFT

- **800 lbs Load Capacity**
- Manual service brake
- Key-controlled
- Maintenance free sealed liquid-acid battery
- Narrow footprint leaves room in aisle to pass by
- Platform table allows for handling of non-palletized materials
- Improves safety & ergonomics by turning a lifting task into a push-pull task

MODEL #	CAPACITY	PLATFORM L X W	WEIGHT	HEIGHT RAISED	HEIGHT LOWERED	BATTERY	OVERALL HEIGHT	OVERALL LENGTH	OVERALL WIDTH
MINI STACKER EMS 850	800	25.75" x 22.75"	243	65"	3.35"	12V/60Ah	68"	41"	24"

HOW TO CHOOSE A LIFT TABLE

1. Identify the characteristics of the materials being handled

Load Weight: Determine the total weight of the load. Lift tables typically support loads ranging from 1,000 to 6,000 lbs in 500 lb increments.

Load Dimensions: Choose a table top size that supports most of the load without being too small (to avoid stability issues) or too large (to prevent excessive overhang that forces workers to reach).

Loading Method:

- For forklift or conveyor loading, a standard lift table suffices.
- For pallet trucks or floor-level loading, consider a ground entry or pit-mounted table. Note that these designs are more costly due to compliance with OSHA standards.

Individual Item Size and Weight:

- Smaller items require lift tables with proper height adjustments for ergonomic positioning.
- Typical lift table height ranges include lowered heights of 6-8 inches and raised heights up to 54 inches.
- Heavier individual items should be positioned at waist level and within easy reach to minimize strain.

2. Assess Workplace Injury Risk

Frequency of Lifting: High-frequency tasks increase the risk of repetitive motion injuries (RMI). Electro-hydraulic lift tables provide precise placement and are better suited for such applications compared to pneumatic or weight-sensitive models.

Reaching Distance: Excessive reaching can lead to injuries. Consider lift tables with load rotation or tilting capabilities to minimize reach distances.

Carrying Distance: Shorter carrying distances reduce injury risks. Mobile lift tables with casters, fork pockets, or dollies can help minimize transition distances.

3. Evaluate Work Environment Conditions

Environmental Factors: Identify any special requirements such as stainless steel construction, specific bearings, or custom power supplies for compliance with industry standards.

Space Constraints: Ensure the lift table fits within the available workspace without creating additional hazards. Some designs may require more floor space than others.

Operator Controls: Choose control options (e.g., pedestal-mounted controls, foot controls, magnetic-backed control boxes) that optimize ergonomics and reduce tripping hazards.

Power Supply:

- Lift tables can operate on single-phase (115V or 230V) or three-phase (230V or 460V) power.
- Higher-capacity tables often require dedicated circuits for single-phase models, while three-phase units are more efficient for high-use applications.

4. Select a lift table that will perform

Customization Options: Standardized models may not meet all ergonomic requirements. If your application has unique needs, work with manufacturers who offer tailored solutions.

Construction Quality: For industrial-grade use, prioritize features like fabricated scissor arms (not tubular steel), all-welded construction, and adherence to ANSI MH29.1 standards.

Component Quality:

- High-quality cam rollers, pivot pins, and bearings are critical for durability.
- Opt for motors with long duty cycles from reputable manufacturers like WEG.

Service Life Enhancements:

- Look for maintenance-friendly designs with grease fittings on pivot points and cam rollers.
- Ensure motors and controls are easily accessible.
- Avoid modular power units that cannot be serviced directly.
- By following these guidelines, you can select a lift table that not only meets your operational needs but also enhances workplace safety and efficiency while minimizing long-term costs.

Large Cylinders



5" bore cylinders provide high efficiency due to larger piston surface, sealed with teflon for extra long life.

15 Min. Motor



Intermittent duty. Able to be run for 15 minutes of every hour. Suitable for medium and high cycle applications.

Trapped Rollers



Captured 'Lift-Lok' secures top and base leg rollers and allows for easy maintenance access when lowered.

HD Scissor Arms



Heavy duty 1.5" x 8" solid scissor arms provide exceptional strength and load stability for safe handling.

LEVEL LOADER



BM-LL-4.4K-28R



**USES
AIRBAG**

BM-LLA-4.4K-28R

- 360 ° rotating manual turn table with 43.7" diameter top
- Low friction bearing supported turntable for nearside loading and unloading
- Spring range capacity from 440lbs - 4,400 lbs
- Fork pockets for easy relocation
- Wide base for exceptional free-standing stability

MODEL #	CAPACITY LBS		HEIGHT INCHES		PLATFORM SIZE	BASE
	MIN	MAX	LOWERED	RAISED		
BM-LL-4.4K-28R	440	4,400	9.5"	28"	43" Dia.	36.6" x 45.25"
BM-LLA-4.4K-28R	440	4,400	9.5"	28"	43" Dia.	36.6" x 45.25"
BM-LLSS-4.4K-28R*	440	4400	9.5"	28"	43" DIA.	36.6" x 45.25"

Can Be Purchased With Or Without Foot Controls
* Stainless Steel



360° Rotation



Fork Pockets



No Power Needed



Extra Wide Base

OPTIONS (SPRING ONLY):



Solid Top



Skirting



Stainless Steel



Rotation Brake



**FINANCING
AVAILABLE**





ROTO-MAX WORK POSITIONER ROTATING SCISSOR LIFT TABLE

- 360 Degree rotating top with heavy duty cam rollers and exclusive Roto-Bearings.
- Cylinders with internal stops, hard chrome plated, polished shafting hydraulic cylinder piston rods
- Surfaces degreased, descaled and finished with safety yellow and blue enamel
- Integral gear pump with check valve, relief valve, solenoid valve
- Smooth steel top with yellow and black safety strips

ADDITIONAL OPTIONS:

- Rotation Brake
- Fork Pockets
- Fork Entry Bars
- Spring Activated Detents
- Special Paint
- Stainless Steel Top
- Rectangular Top
- Stainless Steel Round Top
- Stainless Steel Base Frame
- Steel-It Scissor Arms
- Stainless Steel Bearings
- Water Proof Limit Switch
- Stainless Steel Sub Top
- Remote Power Unit
- Water Resistant RPU
- Stainless Power Box
- Custom Options



FINANCING AVAILABLE



ADD -F FOR FOOT CONTROLS OR -H FOR HAND CONTROLS TO THE MODEL NUMBER

MODEL #	CAPACITY LBS	HEIGHT INCHES		PLATFORM SIZE	LIFT SPEED (SEC)	BASE FRAME	MOTOR (HP)	VOLTAGE
		LOWERED	RAISED					
BM-RM-2.5K-33R	2,500	6.5"	32.5"	43" Dia.	10	30" x 45"	1.5	115
BM-RM-3K-33R	3,000	6.5"	32.5"	43" Dia.	14	30" x 45"	1.5	115
BM-RM-3.5K-33R	3,500	6.5"	32.5"	43" Dia.	19	30" x 45"	2	230/460
STAINLESS STEEL BM-RMSS-2.5K-33R*	2,500	6.5"	32.5"	43" Dia.	10	30" x 45"	1.5	115
STAINLESS STEEL BM-RMSS-3K-33R*	3,000	6.5"	32.5"	43" Dia.	14	30" x 45"	1.5	115
STAINLESS STEEL BM-RMSS-3.5K-33R*	3,500	6.5"	32.5"	43" Dia.	19	30" x 45"	2	230/460

**Each Selection Can Be Purchased With Hand Or Foot Controls
* Stainless Steel/Steel-It Paint for "Wash Down Applications"**

OPTIONS:

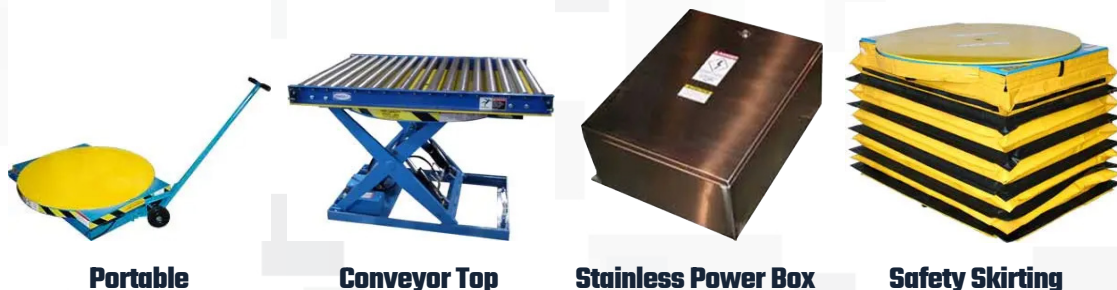



Portable

Conveyor Top

Stainless Power Box

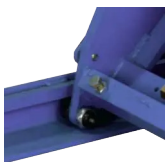
Safety Skirting

15 Min. Motor	Trapped Rollers	HD Scissor Arms
 <p>Intermittent duty. Able to be run for 15 minutes of every hour. Suitable for medium and high cycle applications.</p>	 <p>Captured 'Lift-Lok' secures top and base leg rollers and allows for easy maintenance access when lowered.</p>	 <p>On camroller and pivot points. Regreasable. Lasts longer than lifetime lubricated bearings. Easily serviced.</p>

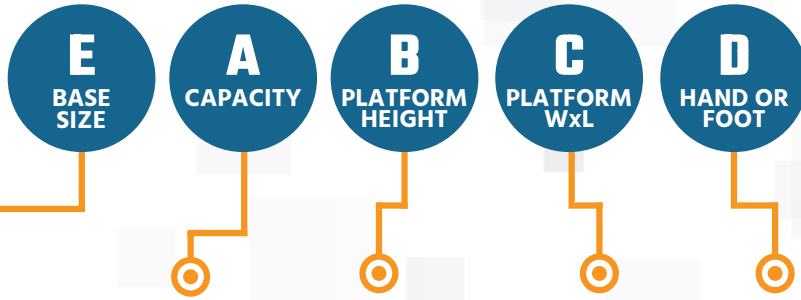

MAX-LIFT SCISSOR LIFT TABLE WIDE BASE

- Internally mounted 1.5 HP 115/230V-I-60 or 230/460-3-60 intermittent duty TENV super torque motor
- 115V operating control voltage
- NEMA constant pressure Magnet backed up-down push button control station with 10' straight or coiled cord
- Cylinders with internal stops
- 10' power cord (connector not included)
- Integral safety restraint maintenance bars
- S.A.E. hoses and fittings
- NEMA - 1 prewired controls and electrical connectors. Control box contains contactor, control transformer, thermal overload and fuse
- Hard, chrome plated, polished shafting hydraulic cylinder piston rods
- Surfaces degreased, descaled and finished with Safety Yellow and Blue enamel
- Smooth steel top with yellow and black safety strips
- Internal gear pump with check valve, relief valve, solenoid valve
- Includes hydraulic oil and filter

BM - MWB3 - 2K - 43R - 3672 - F

A - CAPACITY		
2K = 2000	2.5K = 2500	3K = 3000
3.5K = 3500	4K = 4000	4.5K = 4500
5K = 5000	6K = 6000	

D - HAND OR FOOT
H = HAND
F = FOOT

EXAMPLE NUMBER



43R ONLY

B - PLATFORM HEIGHT								
43R = 43"			55R = 55"			68R = 68"		
C - PLATFORM WxL (IN INCHES)								
36"								
3672 = 36x72	3660 = 36x60	3648 = 36x48	3696 = 36x96	3672 = 36x72	3664 = 36x64	3684 = 36x84	3696 = 36x96	36108 = 36x108
48"								
4872 = 48x72	4860 = 48x60	4848 = 48x48	4896 = 48x96	4872 = 48x72	4864 = 48x64	4884 = 48x84	4896 = 48x96	48108 = 48x108
60"								
6072 = 60x72	6060 = 60x60	6048 = 60x48	6096 = 60x96	6072 = 60x72	6064 = 60x64	6084 = 60x84	6096 = 60x96	60108 = 60x108
72"								
7272 = 72x72	7260 = 72x60	7248 = 72x48	7296 = 72x96	7272 = 72x72	7264 = 72x64	7284 = 72x84	7296 = 72x96	72108 = 72x108

E - BASE SIZE
MWB3 Base = 34.75" x 48"
MWB4 Base = 46.75" x 48"

LOWERED HEIGHT (IN INCHES)		
MWB3		
7.5	7.63	8
MWB4		
7.25	7.5	8

Lowered height not included in part number

OPTIONS:



Conveyor Top



DC Operated



Rotating Top



Tapered Edges

ADDITIONAL OPTIONS:

- Up-Down Push Button with Key Lock-Out
- Adjustable Limit Switch
- Adjustable Lower Limit Switch
- 24 Volt D.C. Power Unit
- Remote Power Unit Pump, Motor & Tank
- Adjustable Flow Valve for Lowering
- Low Temperature Hydraulic Oil
- Low Profile Outboard Mounting of Casters
- All Swivel Lock Casters
- Floor Lock
- Push Handle for Caster Tables
- Fork Pockets
- Hydraulic Fuse
- Portability (2) Fixed Wheels and Dolly Jack
- Portability (2) Fixed (2) Swivel Casters
- Outboard Mounting of Casters
- Handrail Gate
- Pit Frame
- Rotating Top
- Spring Activated Detents
- Round Top
- Electric Interlock



MAX-LIFT SCISSOR LIFT TABLES

- Internally mounted 1.5 HP 115/230V-I-60 or 230/460-3-60 intermittent duty TENV super torque motor
- 115V operating control voltage
- NEMA constant pressure Magnet backed up-down push button control station with 10' straight or coiled cord
- Cylinders with internal stops
- 10' power cord (connector not included)
- Integral safety restraint maintenance bars
- S.A.E. hoses and fittings
- NEMA - 1 prewired controls and electrical connectors. Control box contains contactor, control transformer, thermal overload and fuse
- Hard, chrome plated, polished shafting hydraulic cylinder piston rods
- Surfaces degreased, descaled and finished with Safety Yellow and Blue enamel
- Smooth steel top with yellow and black safety strips
- Internal gear pump with check valve, relief valve, solenoid valve
- Includes hydraulic oil and filter

ADDITIONAL OPTIONS:

- Up-Down Push Button with Key Lock-Out
- Adjustable Limit Switch
- Adjustable Lower Limit Switch
- 24 Volt D.C. Power Unit
- Remote Power Unit Pump, Motor & Tank
- Adjustable Flow Valve for Lowering
- Low Temperature Hydraulic Oil
- Low Profile Outboard Mounting of Casters
- All Swivel Lock Casters
- Floor Lock
- Push Handle for Caster Tables
- Fork Pockets
- Hydraulic Fuse
- Portability (2) Fixed Wheels and Dolly Jack
- Portability (2) Fixed (2) Swivel Casters
- Outboard Mounting of Casters
- Handrail Gate
- Pit Frame
- Rotating Top
- Spring Activated Detents
- Round Top
- Electric Interlock



**FINANCING
AVAILABLE**



A
CAPACITY

B
PLATFORM
HEIGHT

C
PLATFORM
WxL

D
HAND OR
FOOT

BM - MS - 2K - 31R - 2436 - F

A - CAPACITY		
2K = 2000	2.5K = 2500	3K = 3000
3.5K = 3500	4K = 4000	4.5K = 4500
5K = 5000	6K = 6000	

D - HAND OR FOOT
H = HAND
F = FOOT

EXAMPLE NUMBER

43R ONLY

3 PHASE / 460V ONLY

B - PLATFORM HEIGHT											
31R = 31"			43R = 43"			55R = 55"			68R = 68"		
C - PLATFORM WxL (IN INCHES)											
2436 = 24x36	2448 = 24x48	2460 = 24x60	24x48 = 24x48	2460 = 24x60	2472 = 24x72	2564 = 25x64	2572 = 25x72	2596 = 25x96	2684 = 26x84	2696 = 26x96	26108 = 26x108
3636 = 36x36	3648 = 36x48	3660 = 36x60	3648 = 36x48	3660 = 36x60	3672 = 36x72	3664 = 36x64	3672 = 36x72	3696 = 36x96	3684 = 36x84	3696 = 36x96	36108 = 36x108
4836 = 48x36	4848 = 48x48	4860 = 48x60	4848 = 48x48	4860 = 48x60	4872 = 48x72	4864 = 48x64	4872 = 48x72	4896 = 48x96	4884 = 48x84	4896 = 48x96	48108 = 48x108
LOWERED HEIGHT (IN INCHES)											
7.25			7.5			7.63			8		

Lowered height not included in part number

OPTIONS:



Conveyor Top



DC Operated



Rotating Top



Tapered Edges



A
CAPACITY

B
PLATFORM
HEIGHT

C
PLATFORM
WxL

D
HAND OR
FOOT

BM - MDH - 2K - 111R - 6425 - F

A - CAPACITY

2K = 2000 2.5K = 2500 3K = 3000
3.5K = 3500 4K = 4000 5K = 5000

D - HAND OR FOOT

H = HAND
F = FOOT

EXAMPLE NUMBER

62.5R & 86.5R ONLY

B - PLATFORM HEIGHT

62.5R = 62"

86.5R = 86"

111R = 110"

136R = 136"

C - PLATFORM WxL (IN INCHES)

2436 = 24x36	2448 = 24x48	2460 = 24x60	2448 = 24x48	2460 = 24x60	2472 = 24x72	2564 = 25x64	2572 = 25x72	2588 = 25x88	2684 = 26x84	2696 = 26x96	26108 = 26x108
3636 = 36x36	3648 = 36x48	3660 = 36x60	3648 = 36x48	3660 = 36x60	3672 = 36x72	3664 = 36x64	3672 = 36x72	3688 = 36x88	3684 = 36x84	3696 = 36x96	36108 = 36x108
4836 = 48x36	4848 = 48x48		4848 = 48x48	4860 = 48x60	4872 = 48x72	4864 = 48x64	4872 = 48x72	4888 = 48x88	4884 = 48x84	4896 = 48x96	48108 = 48x108

LOWERED HEIGHT (IN INCHES)

14.5

14.5

15

16

Lowered height not included in part number

MAX-LIFT SCISSOR LIFT TABLE DOUBLE HIGH

- Internally mounted 1.5 HP 115/230V-1-60 or 230/460-3-60 intermittent duty TENV super torque motor
- 115V operating control voltage
- NEMA constant pressure Magnet backed up-down push button control station with 10' straight or coiled cord
- Cylinders with internal stops
- 10' power cord (connector not included)
- Integral safety restraint maintenance bars
- S.A.E. hoses and fittings
- NEMA - 1 prewired controls and electrical connectors. Control box contains contac-tor, control transformer, thermal overload and fuse
- Hard, chrome plated, polished shafting hydraulic cylinder piston rods
- Surfaces degreased, descaled and finished with Safety Yellow and Blue enamel
- Smooth steel top with yellow and black safety strips
- Internal gear pump with check valve, relief valve, solenoid valve
- Includes hydraulic oil and filter

ADDITIONAL OPTIONS:

- Up-Down Push Button with Key Lock-Out
- Adjustable Limit Switch
- Adjustable Lower Limit Switch
- Remote Power Unit Pump, Motor & Tank
- Tapered Toe Guards
- Adjustable Flow Valve for Lowering
- Low Temperature Hydraulic Oil
- Diamond Tread Deck
- Ball Transfer
- 24 Volt D.C. Power Unit
- Handrail Gate
- Pit Frame
- Hydraulic Fuse
- Electric Interlock

OPTIONS:



Safety Skirting



Conveyor Top



Stainless Steel



MAX-LIFT SCISSOR LIFT TABLE DOUBLE LONG

- Internally mounted 1.5 HP 115/230V-I-60 or 230/460-3-60 intermittent duty TENV super torque motor
- 115V operating control voltage
- NEMA constant pressure Magnet backed up-down push button control station with 10' straight or coiled cord
- Cylinders with internal stops
- 10' power cord (connector not included)
- Integral safety restraint maintenance bars
- S.A.E. hoses and fittings
- NEMA - 1 prewired controls and electrical connectors. Control box contains contactor, control transformer, thermal overload and fuse
- Hard, chrome plated, polished shafting hydraulic cylinder piston rods
- Surfaces degreased, descaled and finished with Safety Yellow and Blue enamel
- Smooth steel top with yellow and black safety strips
- Internal gear pump with check valve, relief valve, solenoid valve
- Includes hydraulic oil and filter

ADDITIONAL OPTIONS:

- Up-Down Push Button with Key Lock-Out
- Adjustable Limit Switch
- Adjustable Lower Limit Switch
- Remote Power Unit Pump, Motor & Tank
- Adjustable Flow Valve for Lowering
- Low Temperature Hydraulic Oil
- Low Profile Outboard Mounting of Casters
- All Swivel Lock Casters
- Floor Lock
- Push Handle for Caster Tables
- Fork Pockets
- 24 Volt D.C. Power Unit
- Outboard Mounting of Casters
- Handrail Gate
- Pit Frame
- Hydraulic Fuse
- Electric Interlock



A
CAPACITY

B
PLATFORM HEIGHT

C
PLATFORM WxL

D
HAND OR FOOT

BM - MXL - 2K - 43R - 2696 - F

A - CAPACITY		
2K = 2000	3K = 3000	4K = 4000
6K = 6000	8K = 8000	10K = 10000
	12K = 12000	

D - HAND OR FOOT
H = HAND
F = FOOT

EXAMPLE NUMBER

3 PHASE / 460V ONLY

B - PLATFORM HEIGHT											
43R = 43"				55R = 55"				68R = 68"			
C - PLATFORM WxL (IN INCHES)											
2696 = 26x96	26108 = 26x108	26120 = 26x120	26132 = 26x132	27130 = 27x130	27144 = 27x144	27156 = 27x156	27168 = 27x168	27170 = 27x170	27180 = 27x180	27192 = 27x192	27204 = 27x204
26144 = 26x144	3696 = 36x96	36108 = 36x108	36120 = 36x120	27180 = 27x180	27192 = 27x192	36130 = 36x130	36144 = 36x144	27216 = 27x216	36170 = 36x170	36180 = 36x180	36192 = 36x192
36132 = 36x132	36144 = 36x144	4896 = 48x96	26108 = 26x108	36156 = 36x156	36168 = 36x168	36180 = 36x180	36192 = 36x192	36204 = 36x204	36216 = 36x216	48170 = 48x170	48180 = 48x180
48120 = 48x120	48132 = 48x132	48144 = 48x144		48130 = 48x130	48144 = 48x144	48156 = 48x156	48168 = 48x168	48192 = 48x192	48204 = 48x204	48216 = 48x216	
				48180 = 48x180	48192 = 48x192						

LOWERED HEIGHT (IN INCHES)		
7.25	7.5	8

Lowered height not included in part number

OPTIONS:



Safety Skirting



Self Propelled



Ball Transfer



Conveyor Top



FINANCING AVAILABLE

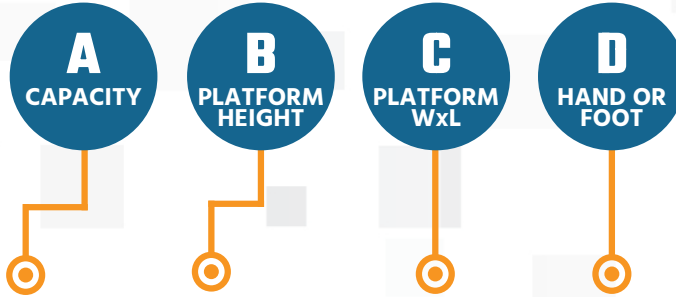

BM - MXW - 2K - 43R - 4850 - F

A - CAPACITY

2K = 2000	3K = 3000	4K = 4000
6K = 6000	8K = 8000	10K = 10000
12K = 12000		

D - HAND OR FOOT

H = HAND
F = FOOT

EXAMPLE NUMBER

3 PHASE / 460V ONLY

B - PLATFORM HEIGHT

43R = 43"

55R = 55"

68R = 68"

C - PLATFORM WxL (IN INCHES)

4850 = 48x50	6050 = 60x50	7250 = 72x50	8450 = 84x50	5066 = 50x66	5072 = 50x72	5084 = 50x84	5098 = 50x98	5086 = 50x86	5096 = 50x96	50110 = 50x110	60086 = 60x86
9650 = 96x50	4860 = 48x60	6060 = 60x60	7260 = 72x60	6066 = 60x66	6072 = 60x72	6084 = 60x84	6098 = 60x98	6096 = 60x96	60110 = 60x110	7286 = 72x86	7296 = 72x96
8460 = 84x60	9660 = 96x60	4874 = 48x74	6074 = 60x74	7266 = 72x66	7272 = 72x72	7284 = 72x84	7298 = 72x98	72110 = 72x110	8486 = 84x86	8496 = 84x96	84110 = 84x110
7274 = 72x74	8474 = 84x74	9674 = 96x74		8466 = 84x66	8472 = 84x72	8484 = 84x84	8498 = 84x98	9686 = 96x86	9696 = 96x96	96110 = 96x110	
				9666 = 96x66	9672 = 96x72	9684 = 96x84	9698 = 96x98				

LOWERED HEIGHT (IN INCHES)

7.25

7.5

8

Lowered height not included in part number

OPTIONS:



Raised Base



Tilting Top



Low Profile Casters



Tapered Toe Guards

MAX-LIFT SCISSOR LIFT TABLE DOUBLE WIDE

- Internally mounted 1.5 HP 115/230V-I-60 or 230/460-3-60 intermittent duty TENV super torque motor
- 115V operating control voltage
- NEMA constant pressure magnet backed up-down push button control station with 10' straight or coiled cord
- Cylinders with internal stops
- 10' power cord (connector not included)
- Integral safety restraint maintenance bars
- S.A.E. hoses and fittings
- NEMA - 1 prewired controls and electrical connectors. Control box contains contactor, control transformer, thermal overload and fuse
- Hard, chrome plated, polished shafting hydraulic cylinder piston rods
- Surfaces degreased, descaled and finished with Safety Yellow and Blue enamel
- Smooth steel top with yellow and black safety strips
- Internal gear pump with check valve, relief valve, solenoid valve
- Includes hydraulic oil and filter

ADDITIONAL OPTIONS:

- Up-Down Push Button with Key Lock-Out
- Adjustable Limit Switch
- Adjustable Lower Limit Switch
- Remote Power Unit Pump, Motor & Tank
- Adjustable Flow Valve for Lowering
- Low Temperature Hydraulic Oil
- Diamond Tread Deck
- Tilting Top
- Low Profile Outboard Mounting of Casters
- All Swivel Lock Casters
- Floor Lock
- Push Handle for Caster Tables
- Fork Pockets
- Portability (2) Fixed Wheels and Dolly Jack
- Portability (2) Fixed (2) Swivel Casters
- Rotating Top
- 24 Volt D.C. Power Unit
- Outboard Mounting of Casters
- Handrail Gate
- Pit Frame
- Hydraulic Fuse
- Electric Interlock



G SERIES SCISSOR LIFT TABLE

- Upper Platform Full Perimeter Safety prevents descent upon obstruction
- Electric circuit reset button in case safety perimeter bar is activated
- Upper limit switch shuts motor off at full height extension reducing wear
- Single acting lift cylinder with flow control to prevent fast lowering
- Low Tension (24v) control box with up and down buttons
- Lifetime lubricated bearings on lift arms
- 1.7HP 115V motor with low amp draw and reliable performance
- Runs on a standard 15 amp circuit



MODEL #	CAPACITY	HEIGHT (+/- 0.125")		PLATFORM SIZE	BASE SIZE	LIFT SPEED (SEC)	MOTOR (HP)	WEIGHT (LBS)
		LOWERED	RAISED					
BM-2G2849	2000	8"	40"	28" x 49"	24.75" x 46"	18.5	1.7	400
BM-2G3849	2000	8"	40"	38" x 49"	24.75" x 46"	18.5	1.7	425
BM-3G3049	3000	8"	40"	30" x 49"	29.25" x 45"	28	1.7	530
BM-3G3849	3000	8"	40"	38" x 49"	29.25" x 45"	28	1.7	550
BM-3G4848	3000	8"	40"	48" x 48"	39" x 47"	28	1.7	550

Each Selection Can Be Purchased With Hand Or Foot Controls

MEDIUM DUTY SCISSOR LIFT TABLE

- High quality Camrollers, Pivot Pins and Bearings
- 4 Standard Tops Available (others upon request)
- Tables conform to or exceed ANSI MH 29.1-1994
- Life-time lubricated bearings
- Internally mounted 1.5 HP 115 Volt TENV motor, 115 Volt operating control voltage
- NEMA constant pressure, magnet backed up/down push button control station with 10' straight cord
- NEMA - 1 prewired controls and electrical connectors, control box with contactor and transformer
- High quality fit and finish
- 10 ft. power cord (connector not included)
- Hard chrome plated, polished shafting and hydraulic cylinder piston rods
- Surface degreased, descaled, finished in Safety Yellow and Blue
- Smooth steel top with yellow and black safety stripes
- S.A.E. hoses and fittings
- Internal gear pump with check valve, relief valve, solenoid valve
- Includes hydraulic oil and filter



OPTIONS:

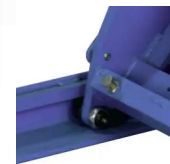

Trapped Rollers



Magnetic Controls



Safety Bars

MODEL #	VERTICAL TRAVEL	CAPACITY	HEIGHT (+/- 0.125")		PLATFORM SIZE	LIFT SPEED (SEC)	BASE FRAME	MOTOR (HP)	VOLTAGE
			LOWERED	RAISED					
BM-MMD-2.2K-43R-2448	36"	2200	7.25"	43.25"	24" x 48"	18	24" x 48"	1.5	115
BM-MMD-2.2K-43R-3648	36"	2200	7.25"	43.25"	36" x 48"	18	24" x 48"	1.5	115
BM-MMD-2.2K-43R-4260	36"	2200	7.25"	43.25"	42" x 60"	18	24" x 48"	1.5	115
BM-MMD-2.2K-43R-4848	36"	2200	7.25"	43.25"	48" x 48"	18	24" x 48"	1.5	115
BM-MMD-3.3K-43R-2448	36"	3300	7.25"	43.25"	24" x 48"	20	24" x 48"	1.5	115
BM-MMD-3.3K-43R-3648	36"	3300	7.25"	43.25"	36" x 48"	20	24" x 48"	1.5	115
BM-MMD-3.3K-43R-4260	36"	3300	7.25"	43.25"	42" x 60"	20	24" x 48"	1.5	115
BM-MMD-3.3K-43R-4848	36"	3300	7.25"	43.25"	48" x 48"	20	24" x 48"	1.5	115

Each Selection Can Be Purchased With Hand Or Foot Controls

ADDITIONAL OPTIONS:

- Accordion Skirting
- Semi-Live Dolly Jack
- Caster Frame Assembly
- Custom Top Sizes



FINANCING AVAILABLE



MAX-LIFT HEAVY DUTY SCISSOR LIFT TABLE

- 1.5" x 8" solid scissor arm
- Internal 3 HP intermittent duty TENV super torque motor
- 115V operating control voltage
- NEMA constant pressure magnet backed up-down push button control station
- NEMA-1 prewired controls and electrical connectors
- Control box contains contactor, control transformer, thermal overload, and fuse
- Cylinders with internal stops
- 10' power cord (connector not included)
- Hard, chrome-plated, polished shafting hydraulic cylinder piston rods
- Surfaces degreased, descaled, and finished with Safety Yellow and Blue enamel
- Smooth steel top with yellow and black safety stripes
- S.A.E. hoses and fittings
- Integral safety restraint maintenance bars
- Internal gear pump with check valve, relief valve, and solenoid valve
- Includes hydraulic oil and filter

ADDITIONAL OPTIONS:





- Key Lock-Out
- Adjustable Limit Switch
- Adjustable Lower Limit Switch
- Remote Power Unit
- Adjustable Flow Valve
- Low Temperature Hydraulic Oil
- Fork Pockets
- Hydraulic Fuse
- Handrail Gate
- Pit Frame
- Rotating or Round Top

ADD -F FOR FOOT CONTROLS OR -H FOR HAND CONTROLS TO THE MODEL NUMBER



MODEL #	VERTICAL TRAVEL	CAPACITY	HEIGHT (+/- 0.125")		LIFT SPEED (SEC)	BASE FRAME	MOTOR (HP)	VOLTAGE
			LOWERED	RAISED				
BM-MHD230-8K-44R-3648	34.5"	8000	9.5"	44"	29	36" x 48"	2	230
BM-MHD460-10K-44R-3648	34.5"	10000	9.5"	44"	44	36" x 48"	2	460

Each Selection Can Be Purchased With Hand Or Foot Controls

Large Cylinders	15 Min. Motor	Trapped Rollers	HD Scissor Arms
 <p>5" bore cylinders provide high efficiency due to larger piston surface, sealed with teflon for extra long life.</p>	 <p>Intermittent duty. Able to be run for 15 minutes of every hour. Suitable for medium and high cycle applications.</p>	 <p>Captured 'Lift-Lok' secures top and base leg rollers and allows for easy maintenance access when lowered.</p>	 <p>Heavy duty 1.5" x 8" solid scissor arms provide exceptional strength and load stability for safe handling.</p>

OPTIONS:



Conveyor Top



Safety Skirting



Rotating Top



Tapered Edges



GUARDIAN LOW PROFILE SCISSOR LIFT TABLE

- Meets and exceeds both U.S. (ANSI) and EU safety standards
- Upper platform fitted with safety perimeter which prevents descent on contact
- Low-tension (24V) control box with up-down buttons
- Electric circuit reset button in case the safety perimeter is actuated
- External power pack equipped with a relief valve against overloading
- Compensated flow valve for controlling lowering speed
- External power pack is supplied with 8' long hoses
- Upper limit switch
- 115 voltage single phase standard
- 230/460 voltage three phase available
- Single acting cylinders with drainage system
- Check valve to stop the lift table lowering in case of hose burst
- Safety clearance between scissors to prevent trapping during operations
- Mechanical blocks for safe maintenance operations
- Self-lubricating bushings on pivot points
- Removable lifting eye(s) to facilitate installation of the lift table







**FINANCING
AVAILABLE**



**ADD -F FOR FOOT
CONTROLS OR
-H FOR HAND
CONTROLS TO THE
MODEL NUMBER**

MODEL #	VERTICAL TRAVEL	CAPACITY	HEIGHT		PLATFORM SIZE	BASE FRAME	LIFT SPEED (SEC)
			LOWERED	RAISED			
BM-GLP-1.1K-34R-3255	30.75"	1100	3.25"	34"	31.5" x 55"	29.5" x 52.75"	10
BM-GLP-1.1K-34R-4055	30.75"	1100	3.25"	34"	39.5" x 55"	29.5" x 52.75"	10
BM-GLP-2.2K-34R-3255	30.75"	2200	3.25"	34"	31.5" x 55"	29.5" x 52.75"	18
BM-GLP-2.2K-34R-4055	30.75"	2200	3.25"	34"	39.5" x 55"	29.5" x 52.75"	18
BM-GLP-3.3K-33R-3261	29.5"	3300	3.25"	33"	31.5" x 61"	29.5" x 52.75"	25
BM-GLP-3.3K-33R-4061	29.5"	3300	3.25"	33"	39.5" x 61"	29.5" x 52.75"	25

Each Selection Can Be Purchased With Hand Or Foot Controls

Safety Bar	Scissor Gaps	Check Valve	Remote Power Unit
 <p>Aluminium safety bar, stops descent in case of contact with obstructions</p>	 <p>Safety clearance between scissors to prevent trapping during operation</p>	 <p>Stops the lift table lowering in the unlikely event of a hose break</p>	 <p>1 HP motor and pump combination is a highly efficient and quiet</p>

OPTIONS:

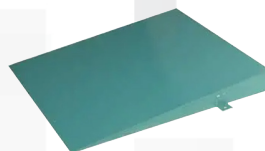

Ramps

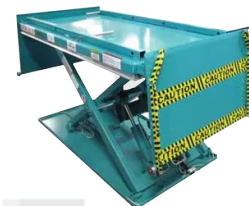

Hinged Ramps

OPTIONS:

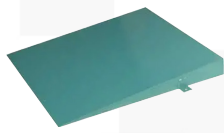

Ramps

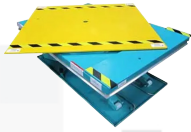

Square Top

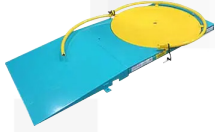

Swing Gate



Steel-It Paint



**GUARDIAN
LIFT-N-SPIN
SCISSOR TABLE**

- Meets ANSI and European safety standards
- Safety perimeter bar stops descent on contact
- Reset button if safety bar is triggered
- 24V control box with up and down buttons
- External power pack with overload relief valve
- Remote power unit with 8 ft hoses
- Compensated flow valve for controlled lowering
- Mechanical blocks for safe maintenance
- 115V single phase standard
- Upper limit switch
- Single acting cylinders with drainage and check valve
- Scissor safety clearance to prevent trapping
- Self lubricating pivot bushings
- Removable lifting eyes for handling and installation

MODEL #	VERTICAL TRAVEL	CAPACITY	HEIGHT		PLATFORM SIZE	LIFT SPEED (SEC)	BASE FRAME	MOTOR (HP)	VOLTAGE
			LOWERED	RAISED					
BM-GLS-2K-35R-4055	30.75"	2000	4.25"	35"	45" DIA.	18	29.5" x 52.75"	1	115

Each Selection Can Be Purchased With Hand Or Foot Controls (Add -F For Foot Controls Or -H For Hand Controls To The Model Number)

Auto Transition Plate	Remote Power Unit	4.25" Lowered	Safety Bar
Automatically raises in lowered position to provide smooth transition to rotating top.	1 HP motor and pump combination is a highly efficient and quiet. Optional 230/460 voltage.	Able to be loaded by hand pallet trucks with the addition of optional ramps	Aluminium safety bar stops descent in case of contact with obstructions

OPTIONS:



Stainless Galvanized



**U-LIFT & E-LIFT
TABLE**

- **U-Lift:** Designed for use with a 21" wide pallet jack
- **E-Lift:** Designed for use with a 27" wide pallet jack
- Load and unload pallets without a ramp
- Meets ANSI and EU safety standards
- Safety perimeter stops descent on contact
- 24V control box with up and down buttons
- Reset button if safety perimeter is triggered
- External power pack with overload relief valve
- Compensated flow valve controls lowering speed
- 8 ft hoses included with power pack
- Upper limit switch
- 115V single phase standard
- 230/460V three phase available
- Single acting cylinders with drainage system
- Hose burst check valve stops lowering
- Scissor safety clearance prevents trapping
- Mechanical maintenance blocks
- Self lubricating pivot bushings
- Removable lifting eyes for installation

MODEL #	VERTICAL TRAVEL	CAPACITY	HEIGHT		PLATFORM SIZE	BASE FRAME	LIFT SPEED (SEC)
			LOWERED	RAISED			
U-LIFT TABLE							
BM-GLPU-2.2K-34R-4556	30.75"	2200	3.13"	33.88"	44.88" x 56"	42" x 52"	18
BM-GLPU-3.3K-33R-4660	29.5"	3300	3.63"	33.125"	45.63" x 59.88"	43" x 56.25"	25
E-LIFT TABLE							
BM-GLPE-2.2K-34R-5650	30.75"	2200	3.13"	33.88"	55.88" x 50"	52" x 54"	18

Each Selection Can Be Purchased With Hand Or Foot Controls (Add -F For Foot Controls Or -H For Hand Controls To The Model Number)



MOTO-CART JR. MLT

- Roller Grip Controls
- Variable Speed
- Adjustable Top Speed
- Power Green Light
- Emergency Stop Bump Switch
- Horn and Key Switch
- Automatic Breaking
- 24 Volt Electrical System
- Curtis Controls
- Color: White w/Black Deck Mat
- Hydraulic Foot Pump
- Trapped Top & Base Rollers
- Maintenance Safety Bars
- (2) 33 AMP Batteries
- On-Board UL-Charger
- Free Wheel Mode
- Pneumatic Non-Marking
- Rubber Drive Wheels
- Poly Casters
- Front Wheel Transaxle Drive
- Battery Gauge
- Full Perimeter Bumper
- Back-Up Beeper
- Variable Lowering Speed
- Circuit Breaker



MLT



ELT

MOTO-CART JR. ELT

- Roller Grip Controls
- Variable Speed
- Adjustable Top Speed
- Power Light
- Emergency Stop Bump Switch
- Key Switch
- Automatic Breaking
- 24 Volt Electrical System
- Curtis Controls
- Color: White
- Hydraulic Lift Cylinder
- Trapped Top & Base Rollers
- Maintenance Safety Bars
- (2) 33 AMP Batteries
- On-Board UL-Charger
- Free Wheel Mode
- Pneumatic Non-Marking
- Rubber Drive Wheels
- Poly Casters
- Front Wheel Transaxle Drive
- Battery Gauge
- Back-Up Beeper
- Upper Limit Switch
- Circuit Breaker

MODEL #	VERTICAL TRAVEL	CAPACITY	HEIGHT		PLATFORM SIZE	MAX SPEED	WEIGHT
			LOWERED	RAISED			
MLT							
BM-MCJR-1K-2339	25"	1000	16"	41"	23" X 39.4"	2.8MPH	498 lbs
ELT							
BM-MCJR-1K-2343	45.5"	1000	18.5"	64"	23" X 43"	2.8MPH	569 lbs
BM-MCJR-M-1K-2339	45.5"	1000	18.1"	35.4"	23.6" X 36.4"	2.8MPH	530 lbs

OPTIONS:



Safety Skirting



Foam Filled Tires



Side Walls



OEM Programming



FINANCING AVAILABLE



MODEL #	VERTICAL TRAVEL	CAPACITY	HEIGHT		PLATFORM SIZE	STRADDLE		MAST HEIGHT
			MIN	MAX		ID	OD	
BM-MXE-150	54"	330 LBS @ 9"LC	5"	59"	18.5" x 23.5"	18.3"	23.3"	70"
BM-MXE-250	64.9"	550 LBS @ 8"LC	5.1"	70"	18.6" x 23.8"	18.9"	22"	86.6"

OPTIONS:

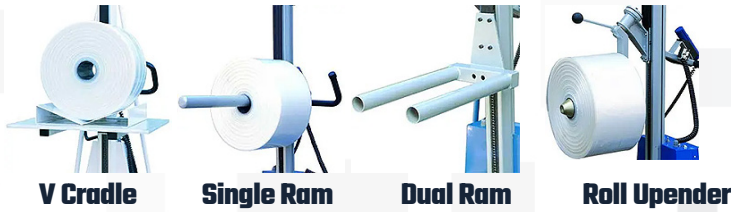

BM-MXE-150

MAX ERGO-LIFTER

- All swivel casters
- Highly maneuverable
- Caster brakes on rear
- Automatic electronic overload protection
- (2)12V Maintenance free and sealed batteries
- Automatic on-board charger and cord
- Upper and lower travel limit switches
- Chain driven lift system
- Safety belt rapid descent protection
- Battery discharge indicator
- Charging status lights
- On/Off toggle switch
- Ergonomic foam wrapped handle
- Hand pendant push button up/down controls
- Control holder on handle
- Charging plug holder on handle
- Quick change attachment options
- Conforms to EN1757, CE marked

MODEL #	VERTICAL TRAVEL	CAPACITY	HEIGHT		PLATFORM SIZE	STRADDLE		MAST HEIGHT
			MIN	MAX		ID	OD	
BM-MMS-20	25"	440	8"	33"	24" x 20"	15	38"	99
BM-MMS-30	44.1"	660	8.9"	53"	25" x 22.8"	49	57.5"	183

OPTIONS:



BM-MMS-20

MAX-MINI-LIFT TOTE & PLATFORM LIFT

- (2) rear swivel casters with brakes
- (2) front rigid casters
- Variable lowering speed
- Rubber traction foot pump
- Foot pump folds up for storage
- Chrome plated lift cylinder
- Cylinder overload protection
- Smooth steel top with backrest
- Chain pulley quietly lifts platform
- Push handle

MODEL #	VERTICAL TRAVEL	CAPACITY	HEIGHT		PLATFORM SIZE	OVERALL SIZE	HANDLE HEIGHT	# OF PUMPS	WEIGHT
			MIN	MAX					
BM-MML-15	20"	330	10"	30"	17.8" X 27.5"	17.8" X 37.5"	39"	16	90 lbs
BM-MML-25	24"	550	12"	36"	19.8" X 32.8"	19.8" X 39.8"	43"	25	160 lbs
BM-MML-50	22"	1100	17"	39"	20.5" X 39.8"	20.5" X 46.8"	44"	44	172 lbs
BM-MML-50XL-N	27.5"	1100	15.8"	43.3"	24.5" X 60"	24.5" X 70"	44"	62	225 lbs
BM-MML-50XL-W	32.3"	1100	14.5"	46.8"	31.5" X 47.3"	31.5" X 57.3"	44"	65	260 lbs
BM-MML-75	22"	1650	17"	39"	20.5" X 39.8"	20.5" X 49.8"	44"	65	369 lbs
BM-MML-100	22"	2200	17"	39"	20.5" X 39.8"	20.5" X 49.8"	44"	75	301 lbs
BM-MML-100XL	31"	2200	17"	48"	31.5" X 39.8"	31.5" X 57.3"	44"	96	358 lbs
BM-MML-30D	45"	660	17"	62"	20.5" X 39.8"	20.5" X 49.8"	44"	53	330 lbs
BM-MML-50D	45"	1100	17"	62"	20.5" X 39.8"	20.5" X 49.8"	44"	68	370 lbs

MML LIFT CARTS

ADDITIONAL OPTIONS:

- Die Handling Top
- All Swivel Casters
- Safety Skirting
- Side Mounted Handle



MML-50



MMLE LIFT CARTS

- Ergonomic push handle
- Push button controls
- (2) front rigid poly casters
- (2) rear swivel poly casters
- Brakes on swivel casters
- Onboard 12V battery
- Trapped top/bottom rollers
- Maintenance safety bars
- Maintenance isolator switch
- Internal automatic charger
- Battery discharge indicator
- Emergency relief valve
- CE certified
- Quality fit and finish

ADDITIONAL OPTIONS:

- Die Handling Top
- All Swivel Casters
- Safety Skirting
- Side Mounted Handle

MMLA LINER ACTUATED LIFT CARTS

- No oil leaks
- No hydraulic drift
- Quiet operation
- Precise actuation
- Brakes on rear casters
- Onboard 12V battery
- Trapped top/bottom rollers
- Maintenance safety bars
- On/Off Switch
- Internal automatic charger
- Battery discharge indicator
- Green/Red charging lights
- All swivel medical casters
- Hand controls on 5' cord
- Quality fit and finish

ADDITIONAL OPTIONS:

- Die Handling Top
- All Swivel Casters
- Safety Skirting
- Side Mounted Handle



FINANCING AVAILABLE



Mounted Controls

Simple push buttons controls are mounted directed on the handle. Visual and color coded.



Onboard BDI

Built-in battery charge indicator clearly shows remaining life of the 12V onboard battery.



Safety Bars

Retractable built-in maintenance safety bars provide a hard mechanical stop during inspection.



Internal Charger

Fully automatic internal charger runs on 110V. Power cord Velcro mounted under platform.

MODEL #	VERTICAL TRAVEL	CAPACITY	HEIGHT		PLATFORM SIZE	WEIGHT
			MIN	MAX		
BM-MMLE-100	18	2,200 lbs	19.3	37.3	20.5 x 39.8	372 lbs
BM-MMLE-100-XL	31	2,200 lbs	17	48	31.5 x 47.3	473 lbs
BM-MMLE-50D	44	1,100 lbs	19.5	63.5	20.5 x 39.8	436 lbs
BM-MMLE-80D	37	1,760 lbs	20	57	20.5 x 39.8	458 lbs



Linear Actuator

Quiet and precise lifting of the platform with no hydraulic drift or potential oil spills.



Onboard BDI

Built-in battery charge indicator clearly shows remaining life of the 12V onboard battery.



Trapped Rollers

Top and bottom rollers are trapped within a steel C channel providing excellent stability.



Hand Controls

On a 5' long coiled cord allows the operator to raise and lower the lift from any position.

MODEL #	VERTICAL TRAVEL	CAPACITY	HEIGHT		PLATFORM SIZE	SPEED (SEC)	
			MIN	MAX		LOWER	LIFT
BM-MMLA151D	34.4	330 lbs	16	50.4	19.7 x 31.5	40	56
BM-MMLA152D	34.4	330 lbs	16	50.4	24 x 35.8	40	56
BM-MMLA251	18.7	550 lbs	14	32.7	19.7 x 31.5	35	41
BM-MMLA252	18.7	550 lbs	14	32.7	24 x 35.8	35	41

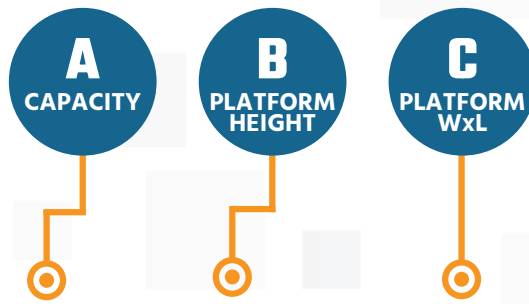

MAX-LIFT SELF-PROPELLED SCISSOR LIFT TABLE

- Heavy duty 24V DC electronics and drive motor
- 24V DC operating control voltage
- Constant pressure up-down push controls
- Cylinders with internal stops
- S.A.E. hoses and fittings
- Integral safety restraint maintenance bars
- NEMA1 prewired controls & electrical connectors
- Control box contains contactor and fuses
- Chrome plated shafting cylinder piston rods
- Surfaces degreased & descaled
- Surfaces finished with Yellow & Blue enamel
- Top with yellow & black safety strips
- Gear pump with check, relief, & solenoid valve
- Truck inactive while lift is raised
- Includes hydraulic oil and filter

BM - MSP - 2K - 43R - 4850 - H

EXAMPLE NUMBER

A - CAPACITY

2K = 2000	2.5K = 2500	3K = 3000
3.5K = 3.5000	4K = 4000	4.5K = 4.5000
5K = 5000	6K = 6000	

NOTE: Top sizes less than 43" wide will have casters that extend beyond the top

B - PLATFORM HEIGHT

48R = 48"

60R = 60"

72R = 72"

C - PLATFORM WxL (IN INCHES)

2448 = 24x48	2460 = 24x60	2472 = 24x72	3648 = 36x48	2464 = 24x64	2472 = 24x72	2484 = 24x84	2496 = 24x96	24108 = 24x108	2484 = 24x84	2496 = 24x96	2684 = 26x84
3660 = 36x60	3672 = 36x72	4848 = 48x48	4860 = 48x60	2564 = 25x64	3664 = 36x64	3672 = 36x72	3684 = 36x84	36108 = 36x108	3684 = 36x84	3696 = 36x96	48108 = 48x108
4872 = 48x72				3696 = 36x96	4864 = 48x64	4872 = 48x72	4884 = 48x84	4884 = 48x84	4896 = 48x96		
				4896 = 48x96							

LOWERED HEIGHT (IN INCHES)

12

12

12

Lowered height not included in part number

Zerk Fittings



On camroller and pivot points. Regreasable. Lasts longer than lifetime lubricated bearings. Easily serviced.

AC Traction Controls



Smoother speed transitions allow the lift to move an inch at a time to avoid damage in tight spaces.

Trapped Rollers

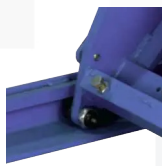

Captured 'Lift-Lok' secures top and base leg rollers and allows for easy maintenance access when lowered.

Ergonomic Handle



Ergonomically contoured handle features easy-to-reach controls that are intuitive to learn and operate.

OPTIONS:

- Static torque control
- AC traction control
- Electric brake release
- Anti-roll braking
- Lugged drive tires
- Programmable parameters
- Battery Discharge Indicator
- Snap fit poly carbonate covers
- Composite bushings
- Detachable power cord
- Rubber bumper skirt
- Ergonomic control handle
- Precise speed control
- Secure battery restraints
- Easy Battery pack access

ADDITIONAL OPTIONS:

- Custom platform sizes
- Custom platform shapes
- Conveyor top
- Radio controlled lift
- Ball transfer top
- Removable side walls
- UHMW top
- Rotating top
- Stainless steel top
- Safety skirting
- Custom colors





MAX-LIFT MOBILE LIFT TABLE

- Heavy duty 24V DC electronics and drive motor
- 24V DC operating control voltage
- Constant pressure up-down push controls
- Cylinders with internal stops
- S.A.E. hoses and fittings
- Integral safety restraint maintenance bars
- NEMA1 prewired controls & electrical connectors
- Control box contains contactor and fuses
- Chrome plated shafting cylinder piston rods
- Surfaces degreased & descaled
- Surfaces finished with Yellow & Blue enamel
- Top with yellow & black safety strips
- Gear pump with check, relief, & solenoid valve
- Lift inactive while cart is in motion
- Limited speed while lift is raised
- Includes hydraulic oil and filter
- Roller variable speed forward/reverse controls
- Rabbit/turtle switch for top speed control
- Power on green light
- Flashing light when battery is low
- Enters "creep" mode when battery is low
- Emergency stop bump switch
- Horn and key switch
- Automatic parking brake (Electro-mechanical)
- Splash proof electronics
- Release brake drive inhibit
- Charge mode drive inhibit
- Throttle fault inhibit
- On-board battery charger
- Free-wheel mode
- Heavy duty articulated transaxle drive
- Two 35 amp maintenance free batteries
- 4% gradability

ADDITIONAL OPTIONS:

- Custom platform sizes
- Custom platform shapes
- Conveyor Top
- Magnet-backed lift controls
- Curtis control programming
- Top side walls
- Outboard mounted casters
- Safety skirting
- Custom colors

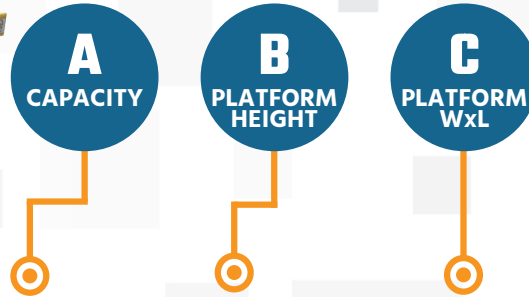

BM - MM - 2K - 42R - 2436 - H

EXAMPLE NUMBER

A - CAPACITY	
2K = 2,000	2.5k = 2,500

B - PLATFORM HEIGHT											
42.25R = 42.25"				54.25R = 54.25"				66.25R = 66.25"			
C - PLATFORM WxL (IN INCHES)											
2641 = 26x41	2648 = 26x48	2660 = 26x60	3641 = 36x41	2648 = 26x48	2660 = 26x60	2672 = 26x72	3648 = 36x48	2664 = 26x64	2672 = 26x72	2684 = 26x84	3664 = 36x64
3648 = 36x48	3660 = 36x60	4841 = 48x41	4848 = 48x48	3660 = 36x60	3672 = 36x72	4848 = 48x48	4860 = 48x60	3672 = 36x72	3684 = 36x84	4864 = 48x64	4872 = 48x72
4860 = 48x60	2436 = 24x36			4872 = 48x72	2448 = 24x48			4884 = 48x84	2564 = 25x64		

LOWERED HEIGHT (IN INCHES)		
18.25	18.25	18.25

Lowered height not included in part number

OPTIONS:



Raised Base



Tilting Top



Low Profile Casters



Dual Caster



**FINANCING
AVAILABLE**





A
CAPACITY

B
PLATFORM
WxL

BM - LPDW - 2K - 2436

EXAMPLE NUMBER

A - CAPACITY

2K = 2,000	2.5K = 2,500	3K = 3,000
------------	--------------	------------

B - PLATFORM WxL (IN INCHES)

2436 = 24x36	2442 = 24x42	2448 = 24x48
3636 = 36x36	3642 = 36x42	3648 = 36x48
4836 = 48x36	4824 = 48x24	4848 = 48x48



OPTIONS:



Ramps



Square Top



Swing Gate



Air Powered

OPTIONS:



Stacker



Cart Mounted



Custom Bin Sizes



Custom Chutes



MAX-PARTS TILTER

- Tilt Range: 0° - 40°
- Tilt Adjustment 1° per pump
- Dual Pump Levers for easy adjustment
- U.S. Patent number 4720232
- Manual Lowering control valve
- Chute locks
- Fork Pockets
- Units are stackable to save space

MODEL #	CAPACITY	TILT	BIN				OVERALL			CHUTE LENGTH
			W	L	H	FT ³	W	L	H	
BM-LPPH-30-12	2,000	0-40°	24	30	12	5	26	40	19.2	16
BM-LPPH-36-12	3,000	0-40°	24	36	12	6	26	46	19.2	16
BM-LPPH-36-16	3,000	0-40°	24	36	16	8	26	46	23.2	16
BM-LPPH-40-16	3,500	0-40°	28	40	16	10.3	30	50	23.2	16



MAX-TILT HYDRAULIC TILT UPENDER

- Triple duty 15 min. internal motor
- Regreasable zerk fittings on pivot points
- Ribbed steel reinforced platform deck
- 115/230 single or 230/460 3 phase voltage
- 30 amp dedicated circuit is required for 115V
- 10' power cord (connector not included)
- Hydraulic gear pump
- Check & solenoid valve, filter & velocity fuse
- Color yellow top with blue frame
- Double acting cylinders
- Pressure compensated control valve
- Tilt limit switch
- Push button magnetic back control box
- Smooth steel decks
- High quality chrome plated cylinder
- Control box with magnetic starter transformer
- Thermal overload and fuses in control box
- Designed for surface or lift table mounting

ADDITIONAL OPTIONS:

- Tapered toe guards
- Lowering beeper
- Raised base
- Remote power unit
- Conveyor top
- Special color
- Adj. tilt limit switch
- Remote control
- Side walls
- Custom top mounts
- Custom lip
- Custom platform sizes
- Custom platform shapes
- Custom tilt speeds

Please contact us to discuss your requirements and we will be happy to design a solution tailored to your needs. **The table below only reflects general parameters.**







ADD -F FOR FOOT CONTROLS OR -H FOR HAND CONTROLS TO THE MODEL NUMBER

MODEL #	CAPACITY	TILT	PLATFORM SIZE		HEIGHT LOWERED	CYLINDERS	MOTOR
			MIN	MAX			
BM-MTU-2K*	2,000 lbs	90°	24 x 36	120 x 108	10	1	1.5 HP
BM-MTU-4K*	4,000 lbs	90°	24 x 36	120 x 108	10	2	1.5 HP
BM-MTU-6K*	6,000 lbs	90°	24 x 36	120 x 108	10	3	1.5 HP
BM-MTU-8K*	8,000 LBS	90°	36 x 36	120 x 108	10	4	2 HP
BM-MTU-10K*	10,000 LBS	90°	36 x 36	120 x 108	10	4	2 HP

*** Contact customer support at 877.543.8776**

Each Selection Can Be Purchased With Hand Or Foot Controls

Zerk Fittings	15 Min. Motor	Ribbed Steel	Adv. Valving
 <p>On camroller and pivot points. Regreasable. Lasts longer than lifetime lubricated bearings. Easily serviced.</p>	 <p>Intermittent duty. Able to be run for 15 minutes of every hour. Suitable for medium and high cycle applications.</p>	 <p>Platform deck is reinforced by ribbed steel to eliminate load deflection and provide for stable load rotation throughout the stroke of the cylinder.</p>	 <p>Pressure compensated control valve eliminates gravitational effects on descent producing smooth rotation.</p>

OPTIONS:



V Cradle



Safety Skirting



Long Decks



Open Frame



FINANCING AVAILABLE



A
CAPACITY

B
PLATFORM
LxW

C
TILT

D
HAND OR
FOOT

BM - MTT - 2K - 3624 - 45T - F

MAX-TILT HYDRAULIC TILT TABLES

- 1.5 HP triple duty internal motor
- Regreasable zerk fittings on pivot points
- Ribbed steel reinforced platform deck
- 115/230 single or 230/460 3 phase voltage
- 30 amp dedicated circuit is required for 115 volt
- 10' power cord (connector not included)
- Hydraulic gear pump
- Check & solenoid valve, filter and velocity fuse
- Color yellow top with blue frame
- Powered up / gravity down on 45° tilt
- Powered up / powered down on 90° tilt
- Tilt limit switch
- Push button magnetic back control box
- Smooth steel deck with 4" high lip on hinge end
- High quality chrome plated cylinder
- Control box with magnetic starter transformer
- Thermal overload and fuses in control box
- Designed for surface or lift table mounting

A - CAPACITY

2K = 2000 4K = 4000 3K = 3000

B - PLATFORM LxW (IN INCHES)

4242 = 42x42
4848 = 48x48

C - TILT

45T = 45°
60T = 60°
90T = 90°

D - HAND OR FOOT

H = HAND
F = FOOT

EXAMPLE NUMBER



Zerk Fittings



On camroller and pivot points. Regreasable. Lasts longer than lifetime lubricated bearings. Easily serviced.

15 Min. Motor



Intermittent duty. Able to be run for 15 minutes of every hour. Suitable for medium and high cycle applications.

Ribbed Steel



Platform deck is reinforced by ribbed steel to eliminate load deflection and provide for stable load rotation throughout the stroke of the cylinder.

Platform Lip



Standard platform lip of 4" holds most containers in place during rotation. Custom lip lengths and shapes are available for higher load centers.

OPTIONS:



Side Tilt



Custom Fixtures



Lift Mounted

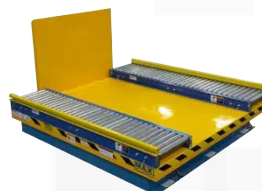

Conveyor Top

ADDITIONAL OPTIONS:

- Custom platform sizes
- Custom platform shapes
- Conveyor top
- Radio controlled lift
- Ball transfer top
- Removable side walls
- UHMW top
- Rotating top
- Stainless steel top
- Safety skirting
- Custom colors



MAX-LIFT AND TILT TABLE

- 1.5 HP intermittent duty TENV super torque motor
- 115V operating control voltage
- NEMA constant pressure. Magnet backed up-down push button control station with 10' straight or coiled cord
- All controller components meet UL and/or CSA specifications
- Cylinders with internal stops
- 10' power cord (connector not included)
- Integral safety restraint maintenance bars
- Tilt limit switch
- Powered up. Gravity down on 45° and powered down on 60° & 90° tilt
- S.A.E. hoses and fittings
- NEMA - 1 prewired controls and electrical connectors
- Control box contains transformer, control contactor, control thermal overload and fuse
- Hard, chrome plated, polished shafting hydraulic cylinder piston rods
- Surfaces degreased, descaled and finished with Safety Yellow and Blue enamel
- Smooth steel top with yellow and black safety strips
- Internal gear pump with check valve, relief valve, solenoid valve
- Includes hydraulic oil and filter

ADDITIONAL OPTIONS:

- Up-Down Push Button with Key Lock-Out
- Adjustable Lift Limit Switch
- Adjustable Tilt Limit Switch
- Custom Platform Designs
- Hydraulic Fuse
- Remote Power Unit Pump, Motor & Tank
- Adjustable Flow Valve for Lowering
- Low Temperature Hydraulic Oil
- Lowering Beeper
- Tapered Toe Guards
- Special Color



BM - MLT45 - 2K - 53R - 2448 - F

EXAMPLE NUMBER

B - PLATFORM HEIGHT		
53R = 53"		
E - TILT		
45 = 45°	60 = 60°	90 = 90°
A - CAPACITY		
2K = 2000		3K = 3000
C - PLATFORM WxL (IN INCHES)		
2448 = 24x48	2460 = 24x60	4848 = 48x48
4860 = 48x60	3660 = 36x60	3648 = 36x48

B - PLATFORM HEIGHT								
65R = 65"								
E - TILT								
45 = 45°			60 = 60°			90 = 90°		
A - CAPACITY								
2K= 2000	4K= 4000	5K= 5000	2K= 2000	3K= 3000	4K= 4000	2K= 2000	3K= 3000	4K= 4000
C - PLATFORM WxL (IN INCHES)								
2564 = 25x64			2564 = 25x64			2564 = 25x64		
4864 = 48x64			4864 = 48x64			4864 = 48x64		
3664 = 36x64			3664 = 36x64			3664 = 36x64		

DOES NOT INCLUDE 2K (2000)

D - HAND OR FOOT
H = HAND
F = FOOT

OPTIONS:



Raised Base



Double Wide



Extended Lip



Side Tilt



FINANCING AVAILABLE





FINANCING AVAILABLE



MMTL MANUAL TILTER

- Independent lift and tilt functions
- Ergonomic handle
- Raise, lower, neutral lever on handle
- "Lift" or "Tilt" selector lever
- Handle rotation lock
- Rotation lock release foot pedal
- Caster brakes on swivel casters
- 6"Ø swivel poly steer casters
- 2.5"Ø rigid poly load casters
- CE certified

MODEL #	CAPACITY	TILT	VERTICAL TRAVEL	LOWERED HEIGHT	HEIGHT			# PUMPS		CYLINDERS	WEIGHT
					ID	OD	L	LIFT	TILT		
BM-MMTL-10M	2200	90°	11"	3.35"	9.2"	22"	31.5"	18	56	2	392 lbs

Separate Lift/Tilt	Ergonomic Handle	Selector Lever	Rotation Lock
 <p>Tilting and lifting operations are independent of one another allowing for individual adjustments.</p>	 <p>Comfortable handle with dimpled grip includes built-in pallet jack style lift, lower and neutral lever.</p>	 <p>Easily switch between the separate lifting and tilting valves by moving the lever to the desired function.</p>	 <p>Handle locks into 3 different positions. Depressing the foot pedal releases the lock and allows repositioning.</p>



MMTE ELECTRIC TILTER

- Independent lift and tilt functions
- Ergonomic handle
- LIFT/LOWER buttons on handle
- Tilt UP/DOWN hand pendant controls
- External automatic charger included
- Battery Discharge Indicator
- BDI On/Off switch
- Emergency stop switch
- Caster brakes on swivel casters
- 6"Ø swivel poly steer casters
- 2.5"Ø rigid poly load casters
- Offset handle for tight maneuverability
- Easily removable back plate
- 12V maintenance free sealed battery
- 105 cycles per full charge
- CE certified

MODEL #	CAPACITY	TILT	VERTICAL TRAVEL	LOWERED HEIGHT	FORK			SPEED (SEC)		CYLINDERS	WEIGHT
					ID	OD	L	LIFT	TILT		
BM-MMTE-10E	2200	90°	11"	3.35"	9.2"	22"	31.5"	2.6	7	2	442 lbs



MXSA WALKIE STACKER

- Adjustable forks
- Adjustable straddle legs
- Ergonomic handle
- 3 position control lever
- Hydraulic pump handle
- Hydraulic foot pump
- 4 bolt pattern steer casters
- Operator safety screen
- Push handles
- Entrapped rollers

MXIBH WALKIE STACKERS

- 12 volt electrical power
- Built-in battery pack and charger
- Interlocked channel and I beam mast
- Full filtration hydraulic system
- Dual lift chains
- Key lock
- Dual adjustable floor locks
- Certified to be OSHA compliant
- Premium steel frame construction
- Maneuverability in tight areas
- Shaft type forks
- Chrome plated lift cylinder
- Pressure compensation valves
- Continuously welded chassis
- No-drift check in neutral
- Built-In relief valve
- Screen mast guard
- One piece door cover

ADDITIONAL OPTIONS:

- Lowering Alarm
- Battery Discharge Meter
- Smart Charger
- Key Switch
- Remote Lift/Lower
- Ram
- Roller Bed Platform
- 36"-48" Wide Fork Carriage
- 3" Tall Load Wheel
- Phenolic Casters
- Poly Casters
- AC Pump Motor System
- ITA Class II Carriage
- ITA Class II Forks
- 36"-60" Long Forks
- 3" Wide Straddle Legs
- Straddle ID/OD Change
- Straddle Length Change
- "V" Groove Casters
- Die Puller



Entrapped Rollers

Rollers for the fork carriage are entrapped within a steel "C" channel providing secure placement of loads.



Ergonomic Handle

Comfortable handle with "lift", "lower" and "neutral" lever. Pumps up the fork carriage similar to a pallet jack.

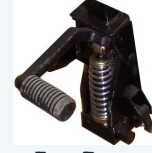

Foot Pump

Forks can be raised by either the foot pump or by pumping the handle, allowing for the operator to decide.



Push Handles

Dual push handles, located at an ergonomic height, reduce the amount of effort required to transport the load.

MODEL #	VERTICAL TRAVEL	CAPACITY	HEIGHT		STRADDLE			FORKS		MAST HEIGHT	
			DOWN	UP	ID	W	L	W	OD	DOWN	UP
BM-MXSA-2200-62H	59"	2200	3"	62"	38"/42"/46"/50"	6"	42"	4"	8.5"-32"	82"	82"



Dual Chain

Heavy duty dual chain lifting system provides efficient and reliable actuation mounted on chrome plated lift cylinder.

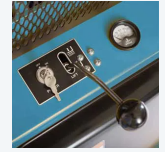

Simple Controls

Centrally located lift/lower stick, amp meter, and key switch make operation of the stacker simple and intuitive.



Floor Lock

Ergonomically placed lever enables dual adjustable floor locks, creating a safe and secure positioning system.



Safety Screen

Heavy duty steel safety screen protects operators from accidental contact with lifting chains and cylinder.

MODEL #	LOAD CENTER	CAPACITY		LIFT		HEIGHT		FORK OD	STRADDLE	
		STD	MAX	STD	MAX	COL	EXT		ID	OD
BM-MXIBH-2000-84H	18"	1000	2000	60"	84"	72"	73.5"	26"	17"	24"
BM-MXIBH-2500-84H	18"-24"	1000	2500	57"	84"	72"	74"	6" - 24"	26"	33"
BM-MXIBH-2500-144H	18"-24"	1500	2500	96"	144"	69"	116"	9.75" - 28"	30"	38"

OPTIONS:



Steel Wheel



Boom Hook



Load Platform



Drum Tilter



Adjustable Forks

Forks can go both over the outrigger or between the outrigger to handle a wide variety of open and closed bottoms.



Simple Controls

Conveniently located intuitive controls are easy to use. Includes lift/lower stick, keyswitch, BDI and charge lights.



FINANCING AVAILABLE



Chain Pulley

Forks are raised by the cylinder which pushes up the mounted chain pulley. The chain then elevates the carriage.



Secure Top

Forks actuate smoothly on two vertical uprights secured by three points of contact per upright for easy positioning.

MODEL #	VERTICAL TRAVEL	CAPACITY	LOAD CENTER	LOWERED		STRADDLE		LIFT SPEED	OVERALL HEIGHT		WEIGHT
				RIGID	ADJ.	ID	OD		COL	EXT	
BM-MMSE-30	58"	660	12"	3.1"	1.8"	14.5"	18.8"	14	67.8"	72"	272 lbs

OPTIONS:



Slide-On Platform



Variable Speed Lowering Control



Entrapped Rollers

Rollers for the fork carriage are entrapped within a steel "C" channel providing secure placement of loads.



Simple Controls

Centrally located lift/lower stick, amp meter, and key switch make operation of the stacker simple and intuitive.



Bolt Pattern

Our pattern of six bolts ensures structural stability of the adjustable straddle legs increasing overall safety.



Push Handles

Dual push handles, located at an ergonomic height, reduce the amount of effort required to transport the load.



MXEM WALKIE STACKERS

- Adjustable fork carriage
- Volt meter
- Key switch
- 120 Ah battery
- 12v 15 amp charger
- Foot actuated floor lock
- Pallet forks
- Positive steer tracking caster
- Adjustable straddle legs
- Ergonomic push handle
- Quick access maintenance cover
- Entrapped rollers
- "Lift"/"Lower" stick
- Operator safety screen
- Built-in relief valve
- Pressure compensating control valve
- Reservoir with integral filter
- All-welded steel mast
- Chrome plated lift cylinder rod
- Heavy-duty lifting chains
- Integral battery charger
- Spring loaded steer handle

MODEL #	LIFT HEIGHT	CAPACITY	FORKS			STRADDLE ID	MAST HEIGHT		WEIGHT
			OD	W	L		DOWN	UP	
BM-MXEM-2200-63H	63"	2200	8.3"-31.5"	3.875"	42"	39"/43"/47"/50.8"	79.5"	79.5"	880 lbs
BM-MXEM-2200-93H	96"	2200	8.3"-31.5"	3.875"	42"	39"/43"/47"/50.8"	70"	110"	945 lbs



FINANCING AVAILABLE



MXSE WALKIE STACKER

- 24volt Curtis transistor control
- Efficient 24V permanent magnet drive motor
- Adjustable straddles or fork over configuration
- Infinitely variable speed for tight turning
- Handle with safety reversing switch and horn
- Maintenance free AGM integral battery pack
- Built-in automatic 110VAC charger
- Battery discharge indicator
- Emergency power disconnect
- Key switch to limit access to approved personnel
- Lift cylinder is hard chrome
- Pump unit with DC motor, solenoid, & gear pump
- Electronic neutral braking
- Electromagnetic disc brake
- Offset steering arm
- Right angle stacking in aisles as narrow as 60"
- Travel, lift, and lower functions in handle
- Angle grips allow easy operation with either hand
- Low mounted arm for minimum steering effort
- All steel construction welded rigid steel chassis
- Fully enclosed wheel guard
- Flush mounted axles
- Removable one piece power head cover

MXSE22-96/116:

- Telescoping high visibility mast Inner rail
- Clear view Plexiglas mast guard
- Dual lifting chains
- Adjustable mast rollers

ADDITIONAL OPTIONS:

- Remote Control
- Slip-on Platform
- 40" Wide Carriage 36" Long Forks

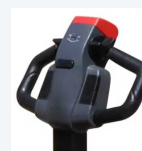

Ergonomic Handle

With infinitely variable speed operation for tight turning in close quarters, safety reversing switch and horn.



Offset Tilter

Provides excellent line of sight for operators allowing for right angle stacking in aisles as narrow as 60".

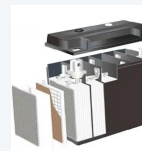

AGM Batteries

Integral AGM batteries support opportunity charging & withstands vibration.



PM Drive System

24V DC permanent magnet drive reduces maintenance and overall operating cost.

2,200 CAPACITY @ 24" LOAD CENTER ITA CLASS II FORK CARRIAGE

MODEL #	LIFT	HEIGHT		FREE LIFT	FORK OD	STRADDLE	
		COL	EXT*			ID	OD
BM-MXSE-2200-78	62"	78.5"	78.3"	55.1"	21.75"	10"	19.9"
BM-MXSE-2200-83	62"	76.4"	83"	55.6"	8"-29.5"	38"-50"	44"-56"
BM-MXSE-2200-134	96"	70.7"	134"	0"	8"-29.5"	38"-50"	44"-56"
BM-MXSE-2200-153	116"	80.7"	153.5"	0"	8"-29.5"	38"-50"	44"-56"

*Extended height is calculated with a load backrest

MXPDX20

**Heavy Duty
2,000 lbs.
60"-144" Lift
24V DC Drive Motor
Zapi Motor Controller**

The MXPDX20 is a resurgence of our legacy MXPDI and MXPDM heavy duty power driven straddle stacker. Suitable for demanding use and greater lift heights. Numerous standard and custom options are available.

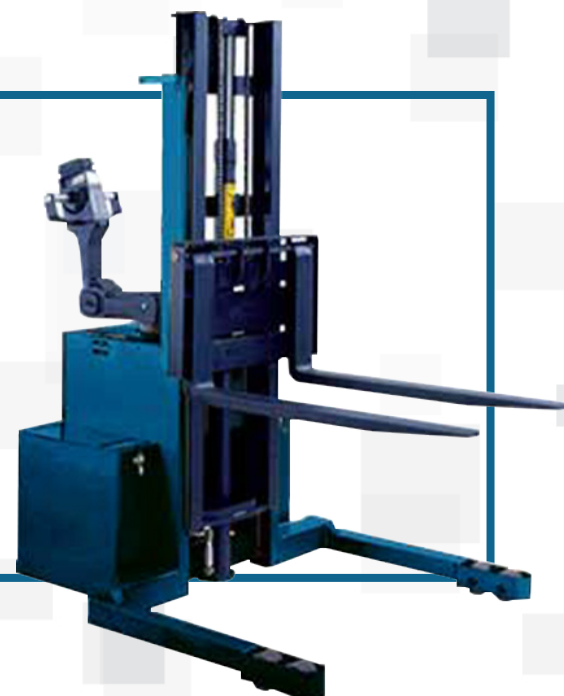

MODEL #	MAX CAPACITY	SIZE			WHEELS	GRADE		BATTERIES	WEIGHT
		W	L	H		LOADED	UNLOADED		
BM-MT-1.5K	1500	20.5"	50.6"	34.5"	9.8"∅	7%	20%	(2) 12v 50Ahr	215 lbs
BM-MT-4K	4000	20.5"	50.6"	34.5"	9.8"∅	3%	10%	(1) 24v 20Ahr	625 lbs

OPTIONS:

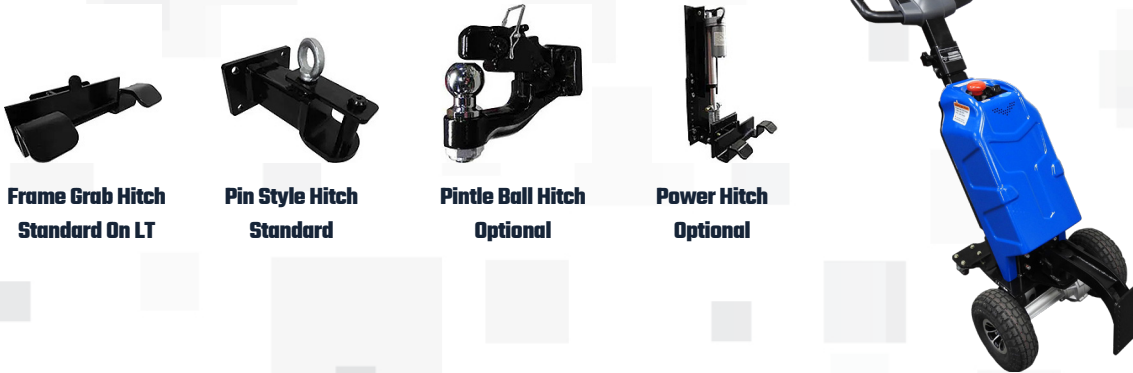

Frame Grab Hitch
Standard On LT

Pin Style Hitch
Standard

Pintle Ball Hitch
Optional

Power Hitch
Optional



**MOTO-TUGGER-LT
ELECTRIC TUG**

- 24-Volt DC Transaxle Drive
- Maintenance free 50AH batteries
- 110VAC plug-in automatic charger
- Variable from 0 mph to 3.1 mph empty
- Variable from 0 mph to 2.8 mph loaded
- (2) 9.8" x 3.3" pneumatic rubber tires
- (2) 3" x 1.3" polyurethane casters
- 60 minute rated electric drive motor
- 180° articulating tow arm
- Pin style & frame grab hitches
- Heavy duty transaxle housing
- Electronic motor braking
- Adjustable ergonomic control head
- Wrap around hand guard
- Infinitely variable travel control
- Reversing belly switch
- Key switch and horn
- Battery discharge indicator
- 7% loaded gradeability
- 20% unloaded gradeability

MODEL #	MAX CAPACITY	SIZE	WHEELS	BATTERIES	WEIGHT
BM-MTET-1.5K	1500	24"W x 18.7"L X 41.6"H	8.75"∅	(2) 12v 22Ahr	120 lbs

OPTIONS:



Slide Clamp Tube

Male Hitch With Safety Latch

Cart Joiner Hitch



**MOTO-TUGGER
ELECTRIC TUG**

- 24-Volt DC Transaxle Drive
- 24-Volt DC Lift Motor/Actuator
- Non-Marking, Flat-Free Tires
- 22 Amp/Hr AGM Batteries
- Quick-change battery system
- Self-diagnostics Controller
- Horn and Key Switch
- Lift button and Throttle
- High/Low Speed Switch
- Small footprint
- Built-in battery with BDI
- ABS shroud
- Travel wheel
- "Rain Proof" (IP-54 rating)
- Quick Hitch System
- Numerous Hitches Available

MODEL #	MAX* CAPACITY	SIZE	SPEED	BATTERIES	RUN TIME	WEIGHT
BM-MTHD-3.5K	3,500 lbs	21 x 50	0-3 MPH	(4) 12v 70Ahr	8 hours	340 lbs
BM-MTHD-5K	5,000 lbs	24 x 35.8	0-3 MPH	(4) 12v 35Ahr	8 hours	400 lbs
BM-MTHD-6.5K	6,500 lbs	24 x 35	0-3 MPH	(4) 12v 70Ahr	8 hours	340 lbs
BM-MTHD-7.5K	7,500 lbs	24 x 35	0-3 MPH	(4) 12v 70Ahr	8 hours	340 lbs

OPTIONS:



Pintle Hook

Pintle Ball

Trailer Hitch

OEM Programming



**MOTO-TUGGER
HD ELECTRIC TUG**

- 24 volt electrical system
- Roller variable speed controls
- High/low switch controls top speed
- Horn & emergency stop button
- Foam filled 9" non-marking tires
- On-board automatic charger
- LED battery indicator gauge
- Transaxle Drive with gas shocks
- Three-position handle
- (4) 12v 35Ahr AGM sealed batteries
- (2) 3-1/2" non-marking casters
- Control handle and head pull down
- 8 hours of operation between charges
- Award winning ergonomic user controller
- Automatic sleep mode
- Regenerative dynamic braking



MAX-JACK MJ55 PALLET TRUCK

- Fork entry & exit rollers
- Beveled forks
- Forks reinforced with gussets
- 7"Ø dual nylon casters
- Adjustable push rods
- Hydraulic pump with overload valve
- Ergonomic handle
- Three position control lever
- Clearly decaled lever operation
- CE certified



Nylon Casters

Dual 7"Ø nylon casters minimize flat spots versus poly casters and offer reduced roll resistance.



Entry Rollers

Fork entry and exit rollers on the beveled end of the 48" long forks allow for easy pallet entry and exit.



Ergonomic Handle

Comfortable handle features control handle with clearly decaled "lift", "lower" and "neutral" positions.



Adjustable Rods

Adjustable push rods keep forks in alignment even after years of use. Simply tighten or loosen as needed.

MODEL #	VERTICAL TRAVEL	CAPACITY	HEIGHT		FORKS			WEIGHT
			DOWN	UP	OD	ID	L	
BM-MJ55-N48	5.1	5,500	2.9	8	20.5	8	48	174 lbs
BM-MJ55-W48	5.1	5,500	2.9	8	27	14.5	48	180 lbs

MAX-JACK MJWPT45 PALLET TRUCK

- 3.25" lowered height
- Heavy gauge tapered forks
- Vertically mounted drive motor is directly mounted to gear housing
- 24V ZAPI travel controller
- Integral AGM batteries
- Quick disconnect power cut off
- Easily removable two piece power head cover
- Electromagnetic brake with neutral braking
- Poly load & drive wheels
- Thumb control travel function
- Lift & lower buttons
- Eight easily accessed grease zerks
- Battery discharge indicator
- Key switch
- Belly button reversing switch
- Horn



ADDITIONAL OPTIONS:

- 48" Load Backrest
- Cold Conditioning
- Rubber Lug Drive Tire
- Poly Traction Tire
- Fork Entry Rollers
- Stability Caster
- 8.1" Battery Compartment
- 33.5" Long Forks

MODEL #	CAPACITY	HEIGHT		FORKS		TURNING RADIUS	OVERALL LENGTH
		DOWN	UP	OD	L		
BM-MJWPT-45	4500	3.25"	8"	22"/27"	45.5"	66"	70.5"

ZAPI Controller



Efficient controller distributes power to create a perfect blend of speed and torque to meet operator requirements.

Ergonomic Handle



With infinitely variable speed operation for tight turning in close quarters, safety reversing switch and horn.

AGM Batteries



Integral AGM batteries support opportunity charging & withstands vibration.

3 Inch Lowered



Heavy gauge tapered forks are only 3.25" lowered for quick and easy pallet access.



FINANCING AVAILABLE



MOTO-CART JR.

- Roller Grip Controls
- Variable Speed
- Adjustable Top Speed
- Power Red Light
- Emergency Stop Bump Switch
- Key Switch
- Automatic Breaking
- 24 Volt Electrical System
- Curtis Controls
- Color: White w/Black Deck Mat
- Battery Reset Switch
- Slide Out Battery Tray
- Brake Disengage Button
- (2) 33 AMP Batteries
- On-Board UL-Charger
- Free Wheel Mode
- Pneumatic Rubber Drive Wheels
- Poly Casters
- Front Wheel Transaxle Drive
- Battery Gauge
- Full Perimeter Bumper
- Back-Up Beeper

MODEL #	CAPACITY	USEABLE DECK	OVERALL SIZE	HEIGHT		MAX INCLINE	WEIGHT
				DECK	HANDLE		
BM-MCJR-1.1K-2436	800 lbs	24 x 36	24 x 38.5	12.5	43	8°	243 lbs
BM-MCJR-1.1K-2446	1,100 lbs	24 x 45.5	25 x 52.5	12.5	43	8°	395 lbs
BM-MCJR-1.1K-3446	1,100 lbs	34 x 45.5	36 x 52.5	12.5	43	8°	430 lbs

OPTIONS:



Tote Rack



Foam Filled Tires



Side Rails



OEM Programming

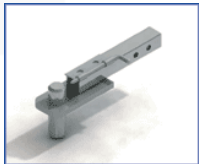

Cart Joiner Hitch



Towing Adapter

Can function as a light duty tugger with adapter



ADDITIONAL OPTIONS:

- Wire Shelving

MOTO-CART ELECTRIC PLATFORM TRUCK

- Roller Speed Controls
- Top Speed Control Switch
- Power Green Light
- Emergency Stop Bump Switch
- Horn and Key Switch
- 24-Volt Electronics and Drive Motor
- Maneuverable Center Wheel Drive
- On-Board Battery Charger
- Free-Wheel Mode
- Articulated Transaxle Drive
- Deep cycle Maintenance-Free Batteries
- Anti-Skid Deck Mat
- Bumper Molding
- Powder Coated White
- Maximum Speed 3 mph
- Automatic Braking
- Automatic Parking Brake
- Flashing Reverse Mode Switch
- Splash Proof Electronics
- Release Brake Drive Inhibit
- Charge Mode Drive Inhibit
- Throttle Fault Inhibit
- Electrical: 120/240 VAC, 50/60 Hz
- Ergonomic handle design
- Spring suspension
- Non-marking tires
- UL/cUL, CE listed smart charging system
- Battery charge indicator
- Welded frame construction
- 10 miles of operation on a single charge

MODEL #	CAPACITY	USEABLE DECK	OVERALL SIZE	HEIGHT		MAX INCLINE	SPEED	WEIGHT
				DECK	HANDLE			
BM-MCSP-1K-24X32	1,000	24 x 32	25.5 x 40	11.5	39	6°	0-3MPH	235 lbs
BM-MCSP-1.5K-25X40	1,500	25.5 x 40	27 x 50	11.5	39	6°	0-3MPH	235 lbs
BM-MCSP-1.5K-25X49	1,500	25.5 x 49	27 x 56.5	11.5	39	6°	0-3MPH	245 lbs
BM-MCSP-1.5K-25X61	1,500	25.5 x 61	27 x 68.5	11.5	39	6°	0-3MPH	255 lbs
BM-MCSP-2K-25X40	2,000	25.5 x 40	27 x 50	11.5	39	6°	0-3MPH	255 lbs
BM-MCSP-2K-25X49	2,000	25.5 x 49	27 x 56.5	11.5	39	6°	0-3MPH	255 lbs
BM-MCSP-2K-25X61	2,000	25.5 x 61	27 x 68.5	11.5	39	6°	0-3MPH	400 lbs

OPTIONS:

Wire Shelving

Foam Filled Tires

OEM Programming

Aluminum

Stainless Steel

Top Shelf

Passivated Stainless

Dual Handles

Pre-Drilled Bolt Holes

Higher Capacity Batteries

Cylinder Rack

Mailroom Basket

Lithium Batteries

Iron Batteries

Phosphate Batteries



MOTO-CART HD PLATFORM TRUCK

- Roller Speed Controls
- Top Speed Control Switch
- Power Green Light
- Emergency Stop Bump Switch
- Horn and Key Switch
- 24-Volt Electronics and Drive Motor
- Maneuverable Center Wheel Drive
- On-Board Battery Charger
- Free-Wheel Mode
- Articulated Transaxle Drive
- Deep cycle Maintenance-Free Batteries
- Anti-Skid Deck Mat
- Bumper Molding
- Powder Coated White
- Maximum Speed 3 mph
- Automatic Braking
- Automatic Parking Brake
- Flashing Reverse Mode Switch
- Splash Proof Electronics
- Release Brake Drive Inhibit
- Charge Mode Drive Inhibit
- Throttle Fault Inhibit
- Ergonomic handle design
- Spring suspension
- Non-marking tires
- UL/cUL, CE listed smart charging system
- Battery charge indicator
- Welded frame construction
- 10 miles of operation on a single charge



**FINANCING
AVAILABLE**



MODEL #	CAPACITY	USEABLE DECK	OVERALL SIZE	HEIGHT		MAX INCLINE	SPEED	BATTERIES
				DECK	HANDLE			
BM-MCHD-1.5K	1,500 lbs	34.5 x 52	36 x 56.5	11.5"	39"	6°	0-3MPH	(2) 35AH
BM-MCHD-2K	2,000 lbs	34.5 x 52	36 x 56.5	11.5"	39"	6°	0-3MPH	(2) 44AH
BM-MCHD-3K	3,000 lbs	34.5 x 52	36 x 56.5	11.5"	39"	6°	0-3MPH	(2) 44AH
BM-MCHD-4K	4,000 lbs	34.5 x 52	36 x 56.5	11.5"	39"	6°	0-3MPH	(2) 44AH

OPTIONS:

Wire Shelving

Foam Filled Tires

OEM Programming

Aluminum

Stainless Steel

Top Shelf

Passivated Stainless

Dual Handles

Pre-Drilled Bolt Holes

Higher Capacity Batteries

Cylinder Rack

Mailroom Basket

Lithium Batteries

Iron Batteries

Phosphate Batteries

MOTO-TANKER

- Self-Priming Diaphragm Pump
- Inline Fuse Protection
- Automatic Shut Off When No Flow
- Farm Nozzle with Swivel
- Comfortable Ergonomic Handle
- Roller Grip Controls
- Variable Speed
- Adjustable Top Speed
- Power Red Light
- Emergency Stop Bump Switch
- Key Switch
- Automatic Breaking
- 24 Volt Electrical System
- Curtis Controls
- Color: White w/Black Deck Mat
- Battery Reset Switch
- FDA/NSF Approved Tank
- Molded-In Legs Reduce Sloshing
- +/-1% Accuracy In-Line Flow Meter
- Meter Easily Field Calibrated
- Display ga/oz/pt/qt/l
- Slide Out Battery Tray
- Brake Disengage Button
- (2) 33 AMP Batteries
- On-Board UL-Charger
- Free Wheel Mode
- Pneumatic Rubber Drive Wheels
- Poly Casters
- Front Wheel Transaxle Drive
- Battery Gauge
- Full Perimeter Bumper
- Back-Up Beeper



MODEL #	CAPACITY	TANK	OVERALL SIZE	HEIGHT		MAX INCLINE	WEIGHT
				DECK	HANDLE		
BM-JRMC-10-TK1	1000	(1) 65 Gal.	25" x 52.5"	12.5"	43"	6°	475 lbs
BM-JRMC-10-TK2	1000	(2) 35 Gal.	36" x 52.5"	12.5"	43"	6°	530 lbs

65 Gal. Tank



Single 65 Gallon Tank or (2) 35 Gallon Tanks for Multiple Liquids.

In-Line Meter



+/-1% Accuracy Rating. 4 Digit Display. Easy Calibration.

Diaphragm Pump



Self-Priming Pump With Automatic Shut Off When No Flow Needed.

3/4" Farm Nozzle



Convenient Built-In Swivel with Ergonomically Designed Handle.

ADD -F FOR FOOT CONTROLS OR -H FOR HAND CONTROLS TO THE MODEL NUMBER



STAINLESS STEEL SCISSOR LIFT TABLE

MODEL #	VERTICAL TRAVEL	CAPACITY	HEIGHT		PLATFORM SIZE	LIFT SPEED (SEC)	BASE FRAME	MOTOR (HP)	VOLTAGE
			LOWERED	RAISED					
BM-SSS-4K-36R	27"	4000	9"	36"	42" X 48"	30	35.5" x 45"	1	115

Each Selection Can Be Purchased With Hand Or Foot Controls

- T304 Stainless Steel Construction
- Relief Valve to Prevent Overloading
- Control Valve for Controlled Descent
- Self-Contained Power Unit
- Integrally Mounted Hydraulic Drive W/Power Unit
- Safety Up-Down Pendant Control
- Dual, SST Powder Coated Hydraulic Cylinders
- Pickle Passivated Finish
- USDA Approved

OPTIONS:



Rotating Top



Semi Portable



Remote Power

ADD -F FOR FOOT CONTROLS OR -H FOR HAND CONTROLS TO THE MODEL NUMBER



ADDITIONAL OPTIONS:

- Handrails
- Tilting top
- Mountd controls
- Custom heights
- Raised base
- Stainless cylinders
- 3 phase voltage
- Custom capacities
- Stainless cams
- Safety locks
- Wash through platform
- Custom sizes

STAINLESS STEEL GROUND ENTRY LIFT

- Heavy-Duty T304 S.S. Construction
- Beveled Low-Profile Platform
- Relief Valve to Prevent Overloading
- Control Valve for Controlled Descent in Case of Electrical Failure
- Self-Contained Power Unit
- Safety Up-Down Foot Pedal Control
- USDA Approved
- 115 Volt Single Phase Hydraulic Drive W/Power Unit
- Narrow 2.5" Wide Sides for Easy Loading/Unloading
- Totally Enclosed Dual (Synchronized) Hydraulic Lift Cylinders
- Pickle Passivated Finish

MODEL #	VERTICAL TRAVEL	CAPACITY	HEIGHT		PLATFORM SIZE	LIFT SPEED (SEC)	BASE FRAME	MOTOR (HP)	VOLTAGE
			LOWERED	RAISED					
BM-SSGE-2.5K-37R	36"	2500	0.5"	37"	42" X 48"	20	48.25" x 54.75"	1	115

Each Selection Can Be Purchased With Hand Or Foot Controls

OPTIONS:

- 3 Phase Power
- Side Guards
- Mounted Controls
- Roll Through Platform
- Maintenance Locks

Have You Wondered the Difference the Right Tool Makes?

ERGONOMIC EVALUATOR

Contact us for a free safety evaluation.
1-800-762-8327

Ballymore Safety Products is proud to provide ergonomic evaluation services thru our website. We use the TuMeke suite of ergonomic analysis tools to generate a MSD, Muscular Skeletal Disorder ranking from 1-10 using the REBA, Rapid Entire Body Assessment. The software also generates a NIOSH Lifting Index for the task that is being completed. When a video is provided, a Ballymore Safety Products Consultant will generate an analysis that includes REBA, NIOSH Lifting Index, and a video output with body links highlighted in Red, Yellow, Green indicating the risk level throughout the task.

Ballymore lifting / lowering solutions will be presented along with a predicted reduction in the back injury rate.

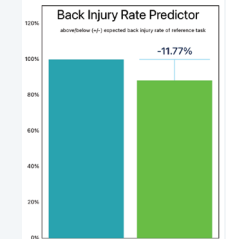
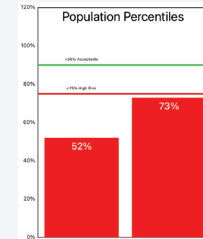

The predicted Back Injury Rate Reduction is based on a study performed by Marras from the Ohio State

University Biodynamics Lab. The study involved 353 industrial jobs. The NIOSH lifting index was calculated for the 353 tasks and injury rates were tracked over a 6 year timeframe. A correlation between the NIOSH Lifting Index and injury rates was defined.

Submit a form and upload a video of the task that needs evaluating.

FREE EVALUATION!

With the addition of Certified Safety Professionals to our staff, we are happy to offer assistance with problem solving related to safety issues that are resulting in back injuries for our customers. We have the ability to help safety professionals quantify the difference an intervention will make in terms of the reduction in the rate of back injuries related to a specific task.



PAUL GILKINSON | CERTIFIED SAFETY PROFESSIONAL

Paul is a seasoned safety professional that has worked with a broad range of companies from Fortune 100 companies to locally owned family businesses over the last 30+ years. He has depth of experience in helping companies reduce the risk of severe injuries in the workplace. His past consulting work includes Retail, Manufacturing, Transportation, Construction, and Distribution Centers.



ZACK MOYA | CERTIFIED SAFETY PROFESSIONAL

Zack Moya is a new addition to Ballymore, who arrives with a storied history in Environmental Health & Safety. With over 12+ years, he has worked with a broad range of companies within the Fortune 100 across various industries including but not limited to: Warehousing, Transportation, Retail, Construction & Energy.

Product Specifications are subject to change without notice. Please confirm critical product specifications at the time of ordering.

Inspection Procedure

Shipments are made FOB factory. Each product has been inspected before shipment. Consignee is responsible to inspect product at time of delivery and should refuse shipment or provide written notice to carrier upon receipt of damaged products.

Carriers and Ballymore will not accept claims if damage is not noted at the time of delivery.

Freight: Ship Prepaid and Add to take advantage of freight cost reductions with our carrier. Service Charge will be added Ballymore can provide estimated freight cost based upon our preferred carriers. Note: Cost are subject to change depending on fuel surcharges, special delivery requirements, etc. Ballymore will not be responsible for differences in freight estimates and actual freight costs.

On collect or 3rd party billing shipments, any freight claims must be handled by the customer, including refused shipments.

WARRANTY (ALL PRODUCTS INCLUDING LIFTS):

- A. Seller warrants goods manufactured by it to be free from defects in material and workmanship for one (1) year following the date of shipment.
- B. Products, or component parts which may be sold by Seller but which are not manufactured by the Seller are not warranted by the Seller, but are sold only with the warranties, if any, of the manufacturers thereof
- C. Any warranty claim by the Buyer must be in writing, containing full details and submitted to Seller within 15 days of when the cause of the claim first came to the Buyer's attention. The relevant product must be held intact by the Buyer to be available for inspection by Seller's staff, agents or representatives.
- D. All product returns require a return authorization prior to shipping (RMA). Returns related to a warranty claim will be accepted on the condition that should Seller, in its reasonable opinion, reject the claim, all costs directly incurred by Seller (including the cost of transport to and from the premises of Seller and inspection) will be paid by the Buyer.
- E. The decision to repair or replace any parts of the product will be made by Seller based on which approach will provide the Buyer with the best service.
- F. The liability of Seller for a breach of any express warranty in these terms and conditions, or breach of an implied warranty, condition or representations required by law to be provided, if any, is limited to (the choice of which is at the discretion of Seller). In the case of product:
 - i. replace the product or provide similar product; or
 - ii. repair the product; or
 - iii. pay to the Buyer the reasonable cost of replacing the product or acquiring an equivalent product; or
 - iv. pay the Buyer the reasonable cost of having product repaired; or
 - v. accept return of the product and refund the purchase price;
- G. To the full extent permitted by law, Seller shall not be held liable for any defects in the product which are the result of:
 - a. improper use or mismanagement of the product by the Buyer;
 - b. operation other than in accordance with the Seller's operating manual or official user supplements and bulletins supplied by Seller;
 - c. use of the product in a manner which is not reasonably contemplated by Seller;
 - d. use of the product with parts which have not been approved for use by Seller;
 - e. modification of the product in a manner not authorized by Seller;
 - f. subjection of the product to unusual or non-recommended conditions, physical, environmental or electrical stress;
 - g. reinstallation or moving of the product by a person other than Seller or a 3rd party approved by Seller;
 - h. the Buyer's failure to comply with any of these terms and conditions; or
 - i. the failure or refusal to install engineering changes or enhancements to the product recommended by Seller.
- H. Notwithstanding any other provision of these terms and conditions, to the full extent permitted by law. Seller shall not be liable to the Buyer for any indirect, consequential, incidental, punitive or special loss (including, without limitation, loss of profits, business, interest or anticipated savings) howsoever arising and whether caused by the negligence of Seller, its employees, agents and/or contractors.
- I. This warranty does not cover labor or other costs or expenses to remove or install any defective, repaired or replaced goods.

Lift Products Manufacturing Core Warranty (For product manufactured by Lift Products Inc.)

- a. 2 year parts/ 5 year structural

RETURN POLICY:

If for any reason Buyer is not satisfied with any standard product received from Seller, Buyer must advise Seller within 15 days of receipt of your order. All items to be returned must be authorized and assigned an RMA number by Seller. We will not accept any returns without a Seller issued RMA number. All returns must be in good condition, in the original packaging (or reasonable substitute) and prepaid within a 15-day period of RMA issue. A 20% -25% re-stocking fee will be applied to all standard items including lifts; 50% on aluminum and stainless. All modified items are non-returnable.

NON-REFUNDABLE ITEMS:

Custom or modified ladders, work platforms, crossovers, modified or custom lifts are non-refundable.

MINIMUM ORDER: \$15.00. Prepay and add shipments are subject to a service charge.

SEE OUR **OTHER CATALOGS** FOR MORE PRODUCTS!



MORE PRODUCTS = MORE SOLUTIONS

ROLLING SAFETY LADDERS • PERSONNEL LIFTS • MATERIAL HANDLING • WORK PLATFORMS • CARTS

Find More Ballymore
Products Here!



501 Gunnard Carlson Drive
Coatesville, PA 19320

251 Waverly Blvd
Coatesville, PA 19320

231 W Stewart Huston Drive
Coatesville, PA 19320

390 Fountain St
Pittsburgh, PA 15668

W226N900 Eastmound Dr.
Waukesha, WI 53186

N3477 US Highway 151
Waupun, WI 53963

456 Lakeshore Parkway
Rock Hill, SC 29730

3545 Centre Circle STE B
Fort Mill, SC 29715

2001 US-61
Lake City, MN 55041

225 Main Street
Tatamy, PA 18085

877.543.8776 • WWW.BALLYMORE.COM/LIFT-PRODUCTS/
610.593.5062 • 800.762.8327 • WWW.BALLYMORE.COM